

KBox A-151-TGL

User Guide Rev. 1.2

Doc. ID: 1069-7855

This page has been intentionally left blank

 KBOX A-151-TGL – USER GUIDE

Disclaimer

Kontron would like to point out that the information contained in this user guide may be subject to alteration, particularly as a result of the constant upgrading of Kontron products. This document does not entail any guarantee on the part of Kontron with respect to technical processes described in the user guide or any product characteristics set out in the user guide. Kontron assumes no responsibility or liability for the use of the described product(s), conveys no license or title under any patent, copyright or mask work rights to these products and makes no representations or warranties that these products are free from patent, copyright or mask work right infringement unless otherwise specified. Applications that are described in this user guide are for illustration purposes only. Kontron makes no representation or warranty that such application will be suitable for the specified use without further testing or modification. Kontron expressly informs the user that this user guide only contains a general description of processes and instructions which may not be applicable in every individual case. In cases of doubt, please contact Kontron.

This user guide is protected by copyright. All rights are reserved by Kontron. No part of this document may be reproduced, transmitted, transcribed, stored in a retrieval system, or translated into any language or computer language, in any form or by any means (electronic, mechanical, photocopying, recording, or otherwise), without the express written permission of Kontron. Kontron points out that the information contained in this user guide is constantly being updated in line with the technical alterations and improvements made by Kontron to the products and thus this user guide only reflects the technical status of the products by Kontron at the time of publishing.

Brand and product names are trademarks or registered trademarks of their respective owners.

©2023 by Kontron Europe GmbH

Kontron Europe GmbH

Gutenbergstraße 2

85737 Ismaning

Germany

www.kontron.com

Intended Use

THIS DEVICE AND ASSOCIATED SOFTWARE ARE NOT DESIGNED, MANUFACTURED OR INTENDED FOR USE OR RESALE FOR THE OPERATION OF NUCLEAR FACILITIES, THE NAVIGATION, CONTROL OR COMMUNICATION SYSTEMS FOR AIRCRAFT OR OTHER TRANSPORTATION, AIR TRAFFIC CONTROL, LIFE SUPPORT OR LIFE SUSTAINING APPLICATIONS, WEAPONS SYSTEMS, OR ANY OTHER APPLICATION IN A HAZARDOUS ENVIRONMENT, OR REQUIRING FAIL-SAFE PERFORMANCE, OR IN WHICH THE FAILURE OF PRODUCTS COULD LEAD DIRECTLY TO DEATH, PERSONAL INJURY, OR SEVERE PHYSICAL OR ENVIRONMENTAL DAMAGE (COLLECTIVELY, "HIGH RISK APPLICATIONS").

You understand and agree that your use of Kontron devices as a component in High Risk Applications is entirely at your risk. To minimize the risks associated with your products and applications, you should provide adequate design and operating safeguards. You are solely responsible for compliance with all legal, regulatory, safety, and security related requirements concerning your products. You are responsible to ensure that your systems (and any Kontron hardware or software components incorporated in your systems) meet all applicable requirements. Unless otherwise stated in the product documentation, the Kontron device is not provided with error-tolerance capabilities and cannot therefore be deemed as being engineered, manufactured or setup to be compliant for implementation or for resale as device in High Risk Applications. All application and safety related information in this document (including application descriptions, suggested safety measures, suggested Kontron products, and other materials) is provided for reference only.

NOTICE

You find the most recent version of the "General Safety Instructions" online in the download area of this product.

NOTICE

This product is not suited for storage or operation in corrosive environments, in particular under exposure to sulfur and chlorine and their compounds. For information on how to harden electronics and mechanics against these stress conditions, contact Kontron Support.

Revision History

Revision	Brief Description of Changes	Date of Issue	Author
1.0	Initial version	2023-Jul-21	CW
1.1	Replaced Ubuntu with Linux	2023-Sept-06	CW
1.2	Added Link in BIOS to the 3.5" - SBC-TGL website	2023-Dec-08	CW

Terms and Conditions

Kontron warrants products in accordance with defined regional warranty periods. For more information about warranty compliance and conformity, and the warranty period in your region, visit <https://www.kontron.com/terms-and-conditions>.

Kontron sells products worldwide and declares regional General Terms & Conditions of Sale, and Purchase Order Terms & Conditions. Visit <https://www.kontron.com/terms-and-conditions>.

For contact information, refer to the corporate offices contact information on the last page of this user guide or visit our website [CONTACT US](#).

Customer Support

Find Kontron contacts by visiting: <https://www.kontron.com/en/support-and-services>.

Customer Service

As a trusted technology innovator and global solutions provider, Kontron extends its embedded market strengths into a services portfolio allowing companies to break the barriers of traditional product lifecycles. Proven product expertise coupled with collaborative and highly-experienced support enables Kontron to provide exceptional peace of mind to build and maintain successful products.

For more details on Kontron's service offerings such as: enhanced repair services, extended warranty, Kontron training academy, and more visit <https://www.kontron.com/en/support-and-services>.

Customer Comments

If you have any difficulties using this user guide, discover an error, or just want to provide some feedback, contact [Kontron support](#). Detail any errors you find. We will correct the errors or problems as soon as possible and post the revised user guide on our website.

Symbols

The following symbols may be used in this user guide

⚠ DANGER

DANGER indicates a hazardous situation which, if not avoided, will result in death or serious injury.

⚠ WARNING

WARNING indicates a hazardous situation which, if not avoided, could result in death or serious injury.

NOTICE

NOTICE indicates a property damage message.

⚠ CAUTION

CAUTION indicates a hazardous situation which, if not avoided, may result in minor or moderate injury

ATTENTION indique une situation dangereuse qui, si elle n'est pas évitée, peut entraîner des blessures mineures ou modérées.



Electric Shock!

This symbol and title warn of hazards due to electrical shocks (> 60 V) when touching products or parts of products. Failure to observe the precautions indicated and/or prescribed by the law may endanger your life/health and/or result in damage to your material.



ESD Sensitive Device!

This symbol and title inform that the electronic boards and their components are sensitive to static electricity. Care must therefore be taken during all handling operations and inspections of this product in order to ensure product integrity at all times.



HOT Surface!

Do NOT touch! Allow to cool before servicing.

Attention : Surface CHAUDE !

Ne pas toucher ! Laissez refroidir avant de procéder à l'entretien.



Laser!

This symbol informs of the risk of exposure to laser beam and light emitting devices (LEDs) from an electrical device. Eye protection per manufacturer notice shall review before servicing.



This symbol indicates general information about the product and the user guide.

This symbol also indicates detail information about the specific product configuration.



This symbol precedes helpful hints and tips for daily use.

For Your Safety

Your new Kontron product was developed and tested carefully to provide all features necessary to ensure its compliance with electrical safety requirements. It was also designed for a long fault-free life. However, the life expectancy of your product can be drastically reduced by improper treatment during unpacking and installation. Therefore, in the interest of your own safety and of the correct operation of your new Kontron product, you are requested to conform with the following guidelines.

High Voltage Safety Instructions

As a precaution and in case of danger, the power connector must be easily accessible. The power connector is the product's main disconnect device.

⚠ CAUTION

Warning

All operations on this product must be carried out by sufficiently skilled personnel only.

⚠ CAUTION



Electric Shock!

Before installing a non hot-swappable Kontron product into a system always ensure that your mains power is switched off. This also applies to the installation of piggybacks. Serious electrical shock hazards can exist during all installation, repair, and maintenance operations on this product. Therefore, always unplug the power cable and any other cables which provide external voltages before performing any work on this product.

Earth ground connection to vehicle's chassis or a central grounding point shall remain connected. The earth ground cable shall be the last cable to be disconnected or the first cable to be connected when performing installation or removal procedures on this product.

Special Handling and Unpacking Instruction

NOTICE



ESD Sensitive Device!

Electronic boards and their components are sensitive to static electricity. Therefore, care must be taken during all handling operations and inspections of this product, in order to ensure product integrity at all times.

⚠ CAUTION

Handling and operation of the product is permitted only for trained personnel within a work place that is access controlled. Follow the "General Safety Instructions" supplied with the product.

Do not handle this product out of its protective enclosure while it is not used for operational purposes unless it is otherwise protected.

Whenever possible, unpack or pack this product only at EOS/ESD safe work stations. Where a safe work station is not guaranteed, it is important for the user to be electrically discharged before touching the product with his/her hands or tools. This is most easily done by touching a metal part of your system housing.

It is particularly important to observe standard anti-static precautions when changing piggybacks, ROM devices, jumper settings etc. If the product contains batteries for RTC or memory backup, ensure that the product is not placed on conductive surfaces, including anti-static plastics or sponges. They can cause short circuits and damage the batteries or conductive circuits on the product.

Lithium Battery Precautions

If your product is equipped with a lithium battery, take the following precautions when replacing the lithium battery.

⚠ CAUTION

CAUTION: Risk of Explosion if the lithium battery is replaced by an incorrect type. Dispose of used lithium batteries according to the Instructions.

ATTENTION: Risque d'explosion si la pile au lithium est remplacée par une pile de type incorrect. Éliminez les piles au lithium usagées conformément aux instructions.

General Instructions on Usage

In order to maintain Kontron's product warranty, this product must not be altered or modified in any way. Changes or modifications to the product, that are not explicitly approved by Kontron and described in this user guide or received from Kontron Support as a special handling instruction, will void your warranty.

This product should only be installed in or connected to systems that fulfill all necessary technical and specific environmental requirements. This also applies to the operational temperature range of the specific board version that must not be exceeded. If batteries are present, their temperature restrictions must be taken into account.

In performing all necessary installation and application operations, only follow the instructions supplied by the present user guide.

Keep all the original packaging material for future storage or warranty shipments. If it is necessary to store or ship the product then re-pack it in the same manner as it was delivered.

Special care is necessary when handling or unpacking the product. See Special Handling and Unpacking Instruction.

Quality and Environmental Management

Kontron aims to deliver reliable high-end products designed and built for quality, and aims to complying with environmental laws, regulations, and other environmentally oriented requirements. For more information regarding Kontron's quality and environmental responsibilities, visit <https://www.kontron.com/about-kontron/corporate-responsibility/quality-management>.

Disposal and Recycling

Kontron's products are manufactured to satisfy environmental protection requirements where possible. Many of the components used are capable of being recycled. Final disposal of this product after its service life must be accomplished in accordance with applicable country, state, or local laws or regulations.

WEEE Compliance

The Waste Electrical and Electronic Equipment (WEEE) Directive aims to:

- ▶ Reduce waste arising from electrical and electronic equipment (EEE)
- ▶ Make producers of EEE responsible for the environmental impact of their products, especially when the product becomes waste
- ▶ Encourage separate collection and subsequent treatment, reuse, recovery, recycling and sound environmental disposal of EEE
- ▶ Improve the environmental performance of all those involved during the lifecycle of EEE



Environmental protection is a high priority with Kontron.

Kontron follows the WEEE directive.

You are encouraged to return our products for proper disposal.

Table of Contents

Symbols	6
For Your Safety	7
High Voltage Safety Instructions	7
Special Handling and Unpacking Instruction	7
Lithium Battery Precautions.....	8
General Instructions on Usage	8
Quality and Environmental Management	8
Disposal and Recycling.....	8
WEEE Compliance.....	8
Table of Contents	9
List of Tables	11
List of Figures	12
1/ Introduction	14
2/ General Safety Instructions	16
2.1. Instructions générales de sécurité.....	17
2.2. Electrostatic Discharge (ESD) Precautions.....	18
2.3. Grounding Methods.....	18
2.4. Instructions for the Lithium Battery	19
3/ Shipment and Unpacking	20
3.1. Packaging.....	20
3.2. Unpacking.....	20
3.3. Scope of Delivery.....	20
3.4. Accessories	20
3.5. Product Identification Type Label	21
4/ Product Features	22
4.1. Front Panel.....	22
4.1.1. Power IN Connector (X101).....	22
4.1.2. Power Button.....	22
4.1.3. Functional Earth Bolt.....	22
4.1.4. Power LED and State LED	23
4.1.5. LAN Ports (X103, X102).....	23
4.1.6. USB 3.2 Gen 2 Ports (X107, X106, X105, X104).....	23
4.1.7. Display Ports (X109, X108).....	23
4.1.8. Serial Ports (X111, X110)	24
4.1.9. Antenna (Ant.1, Ant.2, Ant.3) (option)	24
4.1.10. System Expansion I/O Door (X201).....	24
4.2. Rear Side	25
4.3. Bottom Side.....	25
4.4. Top Side.....	26
4.5. Right and Left Sides.....	26
4.6. Internal Features.....	27
4.6.1. 3.5" SBC On-board Components	28
5/ System Expansion	30
5.1. Before Expanding.....	30
5.2. Storage Expansion Options.....	30
5.3. Wireless Expansion Options	31
5.4. System Expansion I/O Door	32

5.4.1. Audio Line-out (option)	32
5.4.2. Dual CAN Bus (option)	32
5.4.3. Dual LAN (option)	32
5.4.4. Dual RS232 Serial Ports (option)	32
5.4.5. Dual EtherCAT (option)	32
5.4.6. 8-Channel GPIO/DIO (option)	33
5.4.7. Dual LAN and Dual DP (option)	34
6/ Thermal Management	35
6.1. Passive Cooling	35
6.2. Heatsink	35
6.3. Mount Orientation	35
6.4. Minimum Clearance	35
6.5. Third Party Components	36
6.6. Maximum Processor Temperatures	36
7/ Assembly	37
7.1. Before Assembling	37
7.2. Opening the Product	37
7.3. Removing or installing a M.2 Module	39
8/ Installation	40
8.1. Before Installing	40
8.2. Control Cabinet Mounting	40
8.2.1. DIN Rail	40
8.3. Book Mount Bracket	41
8.4. Clearance	42
9/ Starting UP	44
9.1. Before Starting	44
9.1.1. Wiring the Power IN Connector	44
9.2. Connecting to a DC Power Supply	45
9.3. Switching On/Off	46
9.4. Operating System (OS) and Drivers	46
10/ BIOS	47
10.1. Starting the uEFI BIOS	47
10.2. Setup Menus	48
10.3. Main Setup Menu	49
10.4. Advances Setup Menu	50
10.5. Power Setup Menu	55
10.6. Boot Setup Menu	56
10.7. Security Setup Menu	57
10.8. Save and Exit Setup Menu	59
11/ Product Specification	60
11.1. Block Diagram	60
11.2. Hardware Specification	61
11.3. Software Specification	61
11.4. Power Specification	62
11.4.1. Power Supply Protection Requirements	62
11.4.2. Power Consumption	63
11.4.3. Functional Earth	64
11.5. Environmental Specification	64
11.6. Mechanical Specification	65

11.7. Compliance	66
12/ Connectors and LEDs.....	68
12.1. Front Panel Connector Pin Assignments	68
12.1.1. Power IN Connector (X101)	68
12.1.2. LAN Connectors (X102, X103)	68
12.1.3. USB 3.2 Gen 2 Port Connectors (X107, X106, X105, X104).....	70
12.1.4. Display Port Connectors (X109, X108)	71
12.1.5. Serial Port Connectors (X111, X110).....	71
12.1.6. Power Button.....	72
12.1.7. Power LED and STAT LED	72
12.1.8. Antenna (Ant.1, Ant.2, Ant.3).....	72
12.2. System Expansion I/O Door Pin Assignments (X201).....	73
12.2.1. Audio Line-out Connector (option)	73
12.2.2. Dual CAN Bus Connectors (option).....	73
12.2.3. Dual EtherCAT Connectors (option).....	74
12.2.4. Dual LAN Connectors (option)	74
12.2.5. Dual RS232 Serial Port Connectors (option)	75
12.2.6. 8-Channel GPIO/DIO Connector (option)	75
12.2.7. Dual LAN and Dual DP Connectors (option).....	76
12.3. Socket Pin Assignments	77
12.3.1. M.2 Key E 2230 Socket.....	77
12.3.2. M2. Key B 2242/3042/2280 Socket.....	80
12.3.3. M.2 Key M 2280 Slot Socket.....	81
12.3.4. Micro SIM Card Holder	82
12.4. Header and Jumper Pin Assignments	83
12.4.1. RTC Lithium Battery Power Input Header	83
12.4.2. Clear CMOS Selection Jumper	83
12.4.3. M.2 Key B Selection Jumper	83
13/ Maintenance	84
13.1. Cleaning	84
13.2. Replacing the Lithium Battery	84
14/ Storage and Transportation	86
14.1. Storage.....	86
14.2. Transportation	86
15/ Technical Support.....	87
15.1. Returning Defective Merchandise	87
15.2. Warranty.....	88
15.2.1. Limitation/Exemption from Warranty Obligation.....	88
List of Acronyms	89
About Kontron	90

List of Tables

Table 1: Scope of Delivery	20
Table 2: Accessories	20
Table 3: Product Identification	21
Table 4: Power LED and State LED Description.....	23
Table 5: Storage Reference Options.....	30
Table 6: Wireless Reference Options.....	31
Table 7: GPIO Input and Output Channels.....	33

Table 8: Maximum Processor Temperatures	36
Table 9: Navigation Hot Keys Available in the Legend Bar	47
Table 10: Advanced Setup Menu Sub-screens and Functions.....	50
Table 11: Power Setup Menu Sub-screens and Functions	55
Table 12: Boot Setup Menu Sub-screens and Functions.....	56
Table 13: Security Setup Menu Sub-screens and Functions.....	57
Table 14: Save and Exit Setup Menu Sub-screens and Functions.....	59
Table 15: Hardware Specification.....	61
Table 16: Software Specification	61
Table 17: Electrical Specification	62
Table 18: Power Consumption.....	63
Table 19: USB Current and Voltage provided per port.....	63
Table 20: Environmental Specification	64
Table 21: Mechanical Specification.....	65
Table 22: Compliance CE Mark.....	66
Table 23: Compliance RED mark.....	66
Table 24: International Compliance	67
Table 25: Power IN Connector Pin Assignment	68
Table 26: 2.5 GbE LAN Connector Pin Assignment (X102).....	68
Table 27: 1.0 GbE LAN Connector Pin Assignment (X103)	69
Table 28: USB Type A Pin Assignment (USB)	70
Table 29: Display Port Connector Pin Assignment.....	71
Table 30: Serial Port Pin Assignment (x110, X111)	71
Table 31: Audio Lin-out Connector Pin Assignment	73
Table 32: Dual CAN Ports Pin Assignment	73
Table 33: EtherCAT Port Pin Assignment.....	74
Table 34: Dual (GbE) LAN Ports Pin Assignment.....	74
Table 35: Dual RS232 Pin Assignment.....	75
Table 36: GPIO/DIO Connector Pin Assignment	75
Table 37: Dual LAN and Dual DP Module Pin Assignments	76
Table 38: M.2 Key E 2230 Socket Pin Assignment	77
Table 39: M.2 Key B 2242/3042/2280 Socket Pin Assignment.....	80
Table 40: M.2 Key M 2280 Socket Pin Assignment	81
Table 41: SIM Card Holder Pin Assignment.....	82
Table 42: RTC Lithium Battery Connector Pin Assignment	83
Table 43: Clear CMOS Selection Jumper Pin Assignment	83
Table 44: M.2 Key B Selection Jumper.....	83
Table 45: List of Acronyms.....	89

List of Figures

Figure 1: KBox A-151-TGL.....	14
Figure 2: Type Label Example.....	21
Figure 3: Front Panel	22
Figure 4: Rear Side	25
Figure 5: Bottom Side	25
Figure 6: Top Side	26
Figure 7: Left and Right Sides	26
Figure 8: Internal Components Example	27
Figure 9: Top Side On-board Components	28
Figure 10: Bottom Side On-board Components.....	29
Figure 11: Output Application Connected to GPIO.....	33
Figure 12: Input Application Connected to GPIO	34
Figure 13: DIN Rail Clamp (rear side and bottom side).....	40
Figure 14: Book Mount Bracket	41
Figure 15: Keep Out Areas- Horizontal.....	42

Figure 16: Keep Out Areas- Vertical.....	43
Figure 17: Power IN Connector and Mating Power Connector.....	44
Figure 18: Main Setup Menu Example.....	49
Figure 19: Advances Setup Menu Example	50
Figure 20: Power Setup Menu Example.....	55
Figure 21: Boot Setup Menu Example	56
Figure 22: Security Setup Menu Example.....	57
Figure 23: Save and Exit Setup Menu Example.....	59
Figure 24: Block Diagram KBox A-151-TGL.....	60
Figure 25: Mechanical Dimensions (mm).....	65
Figure 26: RP-SMA Standard Connector (female) and Antenna (male)	72
Figure 27: M.2 Key E 2330 Socket.....	77
Figure 28: Lithium Battery.....	85

1/ Introduction

This user guide describes the KBox A-151-TGL designed for DIN Rail applications and also known as product within this user guide. This user guide focuses on describing the product's special features and how to assemble, install, operate and maintain the product properly. New users are recommended to study the instructions within this user guide before switching on the product.

The KBox A-151-TGL is a flexible fanless industrial grade DIN Rail embedded box PC designed for use in performance demanding applications requiring flexible DIN Rail mounting in limited space, 24/7 continuous operation and longtime industrial employment. Based on Kontron's 3.5" Single Board Computer (SBC) using 11th Gen Intel® Core™ U series of processors, the KBox A-151-TGL features a variety of external interfaces to enable extensive connectivity and allows for additional storage and wireless features such as Wi-Fi/Bluetooth and LTE/5G. System expansion increases via the use of a system expansion I/O door on the front panel supporting a wide variety of interface options. All components are selected to ensure a long lifetime and the fanless design ensures a significantly prolonged lifespan and high system availability.

Figure 1: KBox A-151-TGL

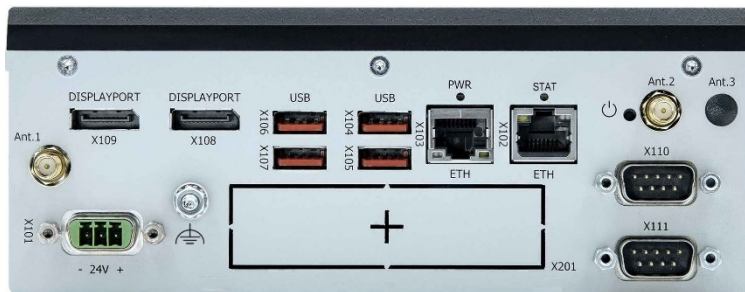

The main features are:

- ▶ Processors
 - ▶ 11th Gen Intel® Core™/Celeron® U series
- ▶ Storage
 - ▶ 2x DDR4 SODIMM up to 64 GB
 - ▶ Storage (up to 1 TB) via M.2 socket
- ▶ Front connectors
 - ▶ 2x DP
 - ▶ 1x 1.0 GbE
 - ▶ 1x 2.5 GbE
 - ▶ 4x USB 3.2 Gen 2
 - ▶ 2x Serial ports (RS232, RS422, RS485 configurable)
- ▶ Wireless connectivity options:
 - ▶ Wi-Fi /Bluetooth
 - ▶ LTE 4G or 5G
- ▶ System expansion I/O door options:
 - ▶ Audio Line-output
 - ▶ Dual CAN
 - ▶ Dual LAN
 - ▶ Dual RS232 serial ports

- ▶ Dual EtherCAT
- ▶ 8- Channel GPIO/Digital IO connector
- ▶ Dual LAN + Dual DP

- ▶ Chassis
 - ▶ Metal chassis with heatsink
 - ▶ Fanless passive cooling

- ▶ Power
 - ▶ Power IN 24 VDC (10 VDC to 30 VDC)



To ensure you have the latest version of this user guide, visit [Kontron's Embedded Box PC, KBox A-151-TGL website.](#)

2/ General Safety Instructions

Please read this passage carefully and take careful note of the instructions, which have been compiled for your safety and to ensure to apply in accordance with intended regulations. If the following general safety instructions are not observed, it could lead to injuries to the operator and/or damage of the product; in cases of non-observance of the instructions Kontron Europe is exempt from accident liability, this also applies during the warranty period.

The product has been built and tested according to the basic safety requirements for low voltage (LVD) applications and has left the manufacturer in safety-related, flawless condition. To maintain this condition and to also ensure safe operation, the operator must not only observe the correct operating conditions for the product but also the following general safety instructions:

- ▶ The product must be used as specified in the product documentation, in which the instructions for safety for the product and for the operator are described. These contain guidelines for setting up, installation and assembly, maintenance, transport or storage.
- ▶ The on-site electrical installation must meet the requirements of the country's specific local regulations.
- ▶ If a power cable comes with the product, only this cable should be used. Do not use an extension cable to connect the product.
- ▶ To guarantee that sufficient air circulation is available to cool the product, please ensure that the ventilation openings are not covered or blocked. If a filter mat is provided, this should be cleaned regularly. Do not place the product close to heat sources or damp places. Make sure the product is well ventilated.
- ▶ Only connect the product to an external power supply providing the voltage type (AC or DC) and the input power (max. current) specified on the Kontron Product Label and meeting the requirements of the Limited Power Source (LPS) and Power Source (PS2) of UL/IEC 62368-1 .
- ▶ Only products or parts that meet the requirements for Power Source (PS1) of UL/IEC 62368-1 may be connected to the product's available interfaces (I/O).
- ▶ Before opening the product, make sure that the product is disconnected from the mains.
- ▶ Switching off the product by its power button does not disconnect it from the mains. Complete disconnection is only possible if the power cable is removed from the wall plug or from the product. Ensure that there is free and easy access to enable disconnection.
- ▶ The product may only be opened for the insertion or removal of add-on cards (depending on the configuration of the product). This may only be carried out by qualified operators.
- ▶ If extensions are being carried out, the following must be observed:
 - ▶ all effective legal regulations and all technical data are adhered to
 - ▶ the power consumption of any add-on card does not exceed the specified limitations
 - ▶ the current consumption of the product does not exceed the value stated on the product label
- ▶ Only original accessories that have been approved by Kontron Europe can be used.
- ▶ Please note: safe operation is no longer possible when any of the following applies:
 - ▶ the product has visible damages or
 - ▶ the product is no longer functioning
 In this case the product must be switched off and it must be ensured that the product can no longer be operated.
- ▶ Handling and operation of the product is permitted only for trained personnel within a work place that is access controlled.
- ▶ CAUTION: Risk of explosion if the lithium battery is replaced incorrectly (short-circuited, reverse-poled, wrong battery type). Dispose of used batteries according to the manufacturer's instructions.
- ▶ This product is not suitable for use in locations where children are likely to be present

Additional Safety Instructions for DC Power Supply Circuits

- ▶ To guarantee safe operation, please observe that:
 - ▶ the external DC power supply must meet the criteria for LPS and PS2 (UL/IEC 62368-1)

- ▶ no cables or parts without insulation in electrical circuits with dangerous voltage or power should be touched directly or indirectly
- ▶ a reliable functional earth connection is provided
- ▶ a suitable, easily accessible disconnecting device is used in the application (e.g. overcurrent protective device), if the product itself is not disconnectable
- ▶ a disconnect device, if provided in or as part of the product, shall disconnect both poles simultaneously
- ▶ interconnecting power circuits of different products cause no electrical hazards
- ▶ A sufficient dimensioning of the power cable wires must be selected – according to the maximum electrical specifications on the product label – as stipulated by EN62368-1 or VDE0100 or EN60204 or UL61010-1 regulations.

2.1. Instructions générales de sécurité

Veillez lire attentivement ce passage et prendre bonne note des instructions, qui ont été compilées pour votre sécurité et pour assurer une application conforme aux réglementations prévues. Le non-respect des consignes de sécurité générales suivantes peut entraîner des blessures pour l'utilisateur et/ou des dommages pour le produit. En cas de non-respect des consignes, Kontron Europe est exonéré de la responsabilité en cas d'accident, ceci s'applique également pendant la période de garantie.

Le produit a été construit et testé conformément aux exigences de sécurité de base pour les applications basse tension (DBT) et a quitté le fabricant dans un état impeccable en matière de sécurité. Pour maintenir cet état et pour garantir également un fonctionnement sûr, l'opérateur doit non seulement respecter les conditions d'utilisation correctes du produit, mais aussi les consignes de sécurité générales suivantes :

- ▶ Le produit doit être utilisé conformément à la documentation du produit, dans laquelle sont décrites les instructions de sécurité pour le produit et pour l'opérateur. Celles-ci contiennent des directives pour la mise en place, l'installation et le montage, la maintenance, le transport ou le stockage.
- ▶ L'installation électrique sur place doit répondre aux exigences des réglementations locales spécifiques du pays.
- ▶ Si un câble d'alimentation est fourni avec le produit, seul ce câble doit être utilisé. N'utilisez pas de rallonge pour connecter le produit.
- ▶ Afin de garantir une circulation d'air suffisante pour refroidir le produit, veuillez vous assurer que les ouvertures de ventilation ne sont pas couvertes ou obstruées. Si un élément filtrant est fourni, celui-ci doit être nettoyé régulièrement. Ne placez pas le produit à proximité de sources de chaleur ou d'endroits humides. Veillez à ce que le produit soit bien ventilé.
- ▶ Ne connectez le produit qu'à une alimentation externe fournissant le type de tension (AC ou DC) et la puissance d'entrée (courant max.) spécifiés sur le Label Produit Kontron et répondant aux exigences de la source d'alimentation limitée (LPS) et de la source d'alimentation (PS2) de la norme UL/IEC 62368-1.
- ▶ Seuls les produits ou les pièces qui répondent aux exigences de la source d'alimentation (PS1) de la norme UL/IEC 62368-1 peuvent être connectés aux interfaces (E/S) disponibles du produit.
- ▶ Avant d'ouvrir le produit, assurez-vous qu'il est bien débranché du secteur.
- ▶ Le fait d'éteindre le produit par son bouton de mise en marche ne le déconnecte pas du secteur. Une déconnexion complète n'est possible que si le câble d'alimentation est retiré de la prise murale ou du produit. Veillez à ce que l'accès soit libre et facile pour permettre la déconnexion.
- ▶ Le produit ne peut être ouvert que pour l'insertion ou le retrait de cartes supplémentaires (selon la configuration du produit). Cette opération ne peut être effectuée que par des opérateurs qualifiés.
- ▶ Si des extensions sont effectuées, les points suivants doivent être respectés :
 - ▶ toutes les réglementations légales en vigueur et toutes les données techniques sont respectées
 - ▶ la consommation électrique d'une carte supplémentaire ne dépasse pas les limites spécifiées
 - ▶ la consommation actuelle du produit ne dépasse pas la valeur indiquée sur l'étiquette du produit.
- ▶ Seuls les accessoires d'origine approuvés par Kontron Europe peuvent être utilisés.
- ▶ Veillez noter que la sécurité des opérations n'est plus possible lorsque l'une des conditions suivantes s'applique.

- ▶ le produit présente des dommages visibles ou
 - ▶ le produit ne fonctionne plus. Dans ce cas, le produit doit être éteint et il faut s'assurer que le produit ne puisse plus être utilisé.
 - ▶ La manipulation et le fonctionnement du produit ne sont autorisés que pour le personnel formé dans un lieu de travail dont l'accès est contrôlé.
 - ▶ ATTENTION: Risque d'explosion si la batterie est remplacée de manière incorrecte (court-circuit, inversion de polarité, mauvais type de batterie). Éliminez les piles usagées conformément aux instructions du fabricant.
 - ▶ Ce produit n'est pas adapté à une utilisation dans des endroits où des enfants sont susceptibles d'être présents
- Instructions de sécurité supplémentaires pour les circuits d'alimentation en courant continu
- ▶ Pour garantir un fonctionnement sûr, veuillez observer ce qui suit:
 - ▶ l'alimentation électrique externe en courant continu doit répondre aux critères des LPS et PS2 (UL/IEC 62368-1)
 - ▶ aucun câble ou pièce non isolée dans les circuits électriques ayant une tension ou une puissance dangereuse ne doit être touché directement ou indirectement
 - ▶ une connexion à la terre fonctionnelle fiable est fournie
 - ▶ un dispositif de déconnexion approprié et facilement accessible est utilisé dans l'application (par exemple, un dispositif de protection contre les surintensités), si le produit lui-même n'est pas en mesure d'être déconnecté.
 - ▶ un dispositif de déconnexion, s'il est prévu dans le produit ou s'il en fait partie, doit déconnecter les deux pôles simultanément
 - ▶ l'interconnexion des circuits électriques de différents produits ne présente aucun risque électrique
 - ▶ Un dimensionnement suffisant des fils du câble d'alimentation doit être choisi - en fonction des spécifications électriques maximales figurant sur l'étiquette du produit - comme stipulé par les réglementations EN62368-1 ou VDE0100 ou EN60204 ou UL61010-1.

2.2. Electrostatic Discharge (ESD) Precautions



A sudden discharge of electrostatic electricity can destroy static-sensitive devices or micro-circuitry.

Proper packaging and grounding techniques are necessary precautions to prevent damage. Always take the following precautions:

1. Transport boards in ESD-safe containers such as boxes or bags.
2. Keep electrostatic sensitive parts in their containers until they arrive at the ESD-safe workplace.
3. Always be properly grounded when touching a sensitive board, component, or assembly.
4. Store electrostatic-sensitive boards in protective packaging or on antistatic mats.

2.3. Grounding Methods

Observing the following grounding guidelines, avoids electrostatic damage to the product:

1. Cover workstations with approved antistatic material. Always wear a wrist strap connected to the workplace. Always use properly grounded tools and equipment.
2. Use antistatic mats, heel straps, or air ionizers for more protection.
3. Always handle electrostatically sensitive components by their edge or by their casing.
4. Avoid contact with pins, leads, or circuitry.
5. Switch off power and input signals before inserting and removing connectors or connecting test equipment.

6. Keep the work area free of non-conductive materials such as ordinary plastic assembly aids and Styrofoam.
7. Use only field service tools that are conductive, such as cutters, screwdrivers, and vacuum cleaners.
8. Always place drives and boards PCB-assembly-side down on the foam.

2.4. Instructions for the Lithium Battery

The product is equipped with a Kontron specific lithium battery BR2032 with cable and is not designed to operate without a lithium battery. If the lithium battery is empty or disconnected, the BIOS settings will be set to the factory defaults. Replace the Kontron specific lithium battery assembly only with the same type of lithium battery (BR2032 with cable) or with a Kontron recommended lithium battery type, see Table 2: Accessories

To replace the lithium battery, observe the instructions in Chapter 13.2: Replacing the Lithium Battery.

⚠ CAUTION

Danger of Explosion if the lithium battery is incorrectly placed!

- ▶ Replace only with the same or equivalent type recommended by the manufacturer
- ▶ Dispose of used batteries according to the manufacture's instructions

VORSICHT- Explosionsgefahr bei unsachgemäßem Austausch der Batterie!

- ▶ Ersatz nur durch denselben oder einen vom Hersteller empfohlenen gleichwertigen Typ
- ▶ Entsorgung gebrauchter Batterien nach Angaben des Herstellers

ATTENTION- Risque d'explosion avec l'échange inadéquat de la batterie!

- ▶ Remplacement seulement par le même ou un type équivalent recommandé par le producteur

- ▶ L'évacuation des batteries usagées conformément à des indications du fabricant

PRECAUCION- Peligro de explosión si la batería se sustituye incorrectamente!

- ▶ Sustituya solamente por el mismo o tipo equivalente recomendado por el fabricante
- ▶ Disponga las baterías usadas según las instrucciones del fabricante

ADVARSEL- Lithiumbatteri -- Eksplosionsfare ved fejlagtig håndtering!

- ▶ Udskiftning må kun ske med batteri af samme fabrikat og type
- ▶ Levér det brugte batteri tilbage til leverandøren

ADVARSEL- Eksplosjonsfare ved feilaktig skifte av batteri!

- ▶ Benytt samme batteritype eller en tilsvarende type anbefalt av apparatfabrikanten
- ▶ Brukte batterier kasseres i henhold til fabrikantens instruksjoner

VARNING- Explosionsfara vid felaktigt batteribyte!

- ▶ använd samma batterityp eller en ekvivalent typ som rekommenderas av apparattillverkaren

- ▶ assera använt batteri enligt fabrikantens instruktion

VAROITUS- Paristo voi räjähtää, jos se on virheellisesti asennettu!

- ▶ Vaihda paristo ainoastaan latteval- mistajan suosittelemaan tyyppiln
- ▶ Hävitä käytetty paristo valmistajan ohjeiden mukaisesti

After removing the lithium battery, dispose of the lithium battery according to the regulations within your region.



Do not dispose of lithium batteries in general trash collection. Dispose of the lithium battery according to the local regulations dealing with the disposal of these special materials, (e.g. to collecting points for lithium battery disposal).



The product is not designed to operate without a lithium battery. If the lithium battery is empty or disconnected, the BIOS settings will be set to the factory defaults.

3/ Shipment and Unpacking

3.1. Packaging

The KBox A-151-TGL is packaged together with all parts, in a product specific cardboard package designed to provide adequate protection and absorb shock.

3.2. Unpacking

To unpack the product perform the following:

1. Remove packaging.
2. Do not discard the original packaging. Keep the original packaging for future transportation or storage.
3. Check the delivery for completeness by comparing the delivery with the original order.
4. Keep the associated paperwork. It contains important information for handling the product.
5. Check the product for visible shipping damage.

If you notice shipping damage or inconsistencies between the contents and the original order, contact your dealer.

3.3. Scope of Delivery

The scope of delivery describes the parts included in your delivery. Check that the delivery is complete, and contains the items listed. If damaged or missing items are discovered, contact your dealer.

Table 1: Scope of Delivery

Product	Description
KBox A-151-TGL	KBox A-151-TGL with defined processor and mounting (DIN Rail Clamp or Book Mount Bracket)
Phoenix Power connector	3-pin Phoenix power connector (PSC 1.5/ 3-F)
General safety instructions	General safety instructions when operating or handling IT equipment

3.4. Accessories

Table 2: Accessories

Part Number	Part	Description
EE04-100001-01	3-pin Phoenix power connector	3-pin Phoenix power connector (PSC 1.5/3-F)
ER40-100001-01	Power supply 24 VDC with 3-pin Phoenix connector	External AC/DC Power supply 24 VDC, 64 W at 40°C, with 1.4 m DC cable and 3-pin Phoenix power connector (PSC 1.5/ 3-F)
840-0059	Power cable EU	Power cable AC mains (2 m) to external Europe plug
840-0115	Power cable UK	Power cable AC mains (1.8 m) to external UK plug
840-0405 /	Power cable US	Power cable AC mains (1.8 m) to external USA plug
0-0064-4317	Power cable US	Power cable AC mains (2 m) to external USA plug
1068-4995	BR2032 3V Lithium battery	BR2032 3V Lithium battery with cable

Part Number	Part	Description
9-4701-0026	KBox A-151_DIN Rail Rear	DIN Rail clamp and two M4x6 Torx screws to mount the clamp on the rear side
9-4701-0027	KBox A-151_DIN Rail Bottom	DIN Rail clamp and two Mx4 Torx screws to mount the clamp on the bottom side
9-4701-0028	KBox A-151 Book Mount Bracket	Book mount bracket and two M4x6 Torx screws to mount the bracket on the rear side

3.5. Product Identification Type Label

The KBox A-151-TGL is part of Kontron's DIN Rail embedded Box PC. Kontron's A-Series is intended for control cabinet applications.

Table 3: Product Identification

System Type	Product Designation	Model	Description
KBox A	KBox A-151	KBox A-151-TGL	Corresponds to system configurations based on 3.5"-SBC-TGL with 11th Gen Intel® Core™/Celeron® series processors

The type label includes important product specific Information such as the electrical specification and the compliance of the ordered product variant.

Figure 2: Type Label Example

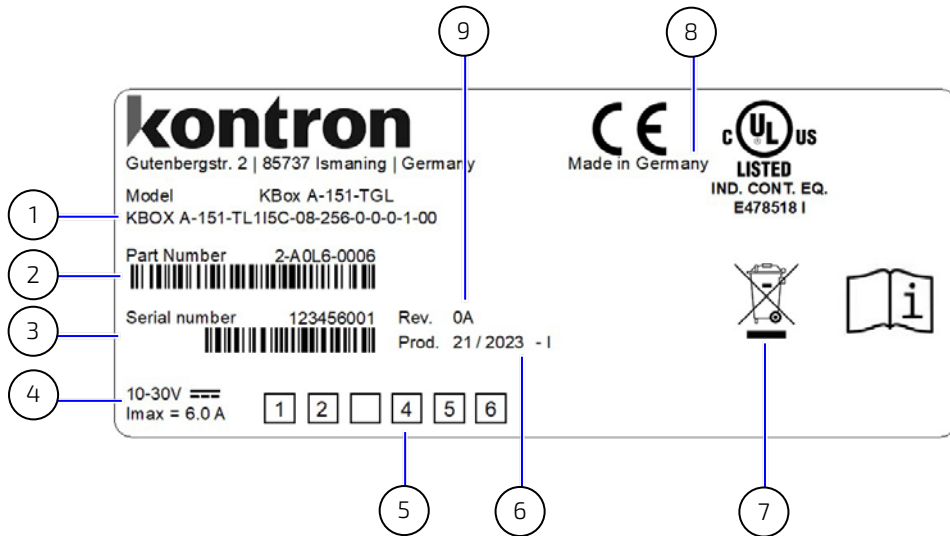

- | | |
|------------------------------|------------------------|
| 1 Model/Product family | 5 For Internal use |
| 2 Part Number with bar code | 6 Production date |
| 3 Serial Number and bar code | 7 Dispose of correctly |
| 4 Electrical specification | 8 Compliance |
| | 9 Revision |

4/ Product Features

4.1. Front Panel

The front panel features all the I/O interfaces, status LEDs and the power connection.

Figure 3: Front Panel

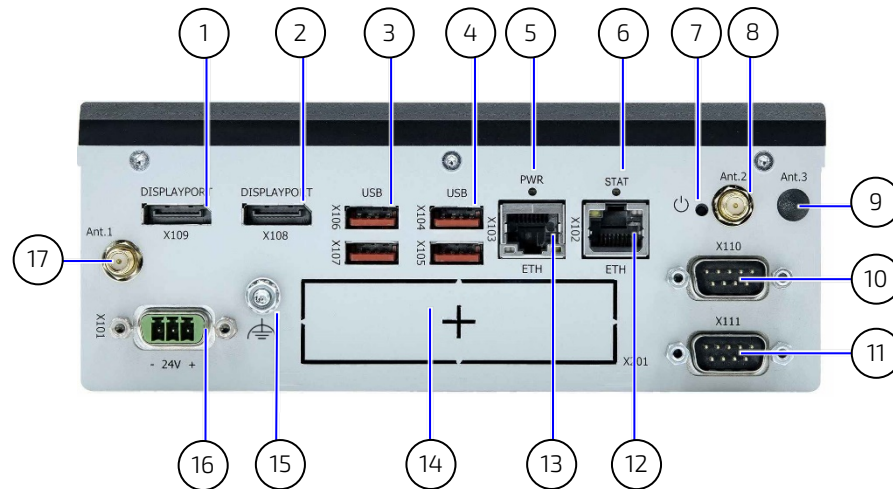

- | | | | |
|---|--|----|----------------------------------|
| 1 | Display port (X109) | 9 | Antenna (ANT.3) |
| 2 | Display port (X108) | 10 | Serial port (X110) |
| 3 | USB 3.2 Gen 2 ports 2 and 1 (X106/107) | 11 | Serial port (X111) |
| 4 | USB 3.2 Gen 2 ports 4 and 3 (X104/105) | 12 | 2.5 GBE LAN port 1 (X102) |
| 5 | Power LED | 13 | 1 GBE LAN port 2 (X103) |
| 6 | State LED | 14 | System expansion I/O door (X201) |
| 7 | Power button | 15 | Functional earth bolt |
| 8 | Antenna (ANT.2) | 16 | Power IN connector (X101) |
| | | 17 | Antenna (ANT.1) |

4.1.1. Power IN Connector (X101)

The 3-pin Power IN connector (PSC 1.5/ 3-M) connects to an appropriate DC power supply using the supplied mating power connector (PSC 1.5/ 3-F). To wire the mating power connector, see Chapter 9.1.1: Wiring the Power IN Connector.

For the pin assignment of the Power IN connector, see Chapter 12.1.1: Power IN Connector (X101).

4.1.2. Power Button

The power button switches on or switches off the product by performing an orderly shutdown. Pressing the power button for more than four seconds switches the product from the 'on' to 'off' state.

4.1.3. Functional Earth Bolt

The functional earth bolt connects to the chassis ground.

4.1.4. Power LED and State LED

The Power LED and State LED indicate the product's power and state.

Table 4: Power LED and State LED Description

STAT LED (green)	PWR LED (yellow)	Description
On	On	S0 (Full On)
Blinking	On	S3 (Suspend-to-RAM)
Off	On	S4 (Suspend-to-Disk)
Off	On	S5 (Soft Off)
Off	Off	G3 (Mechanical Off)

4.1.5. LAN Ports (X103, X102)

The Ethernet port (X102) supports one channel of 10/100/1000/2500 Mbit Ethernet and the Ethernet port (X103) supports one channel of 10/100/1000 Mbit Ethernet. To achieve the specified Ethernet port performance, Category 5 twisted pair cables must be used with 10/100 Mbit and Category 5E, 6 or 6E with 1 GbE/2.5 GbE Ethernet networks.



The orientation of the Ethernet connector (X103 and X102) status LEDs differs.

For the pin assignment of the Ethernet LAN ports and information regarding the Ethernet status LEDs, see Chapter 12.1.2: LAN Connectors (X102, X103).

4.1.6. USB 3.2 Gen 2 Ports (X107, X106, X105, X104)

The four USB port (X107, X106, X105 and X104) support USB 3.2 Gen 2 compatible devices.



USB 3.2 Gen 2 ports are backwards compatible with USB 2.0.

For the pin assignment of the USB 3.2 Gen 2 ports, see Chapter 12.1.3: USB 3.2 Gen 2 Port Connectors (X107, X106, X105, X104).

4.1.7. Display Ports (X109, X108)

The two Display Ports (DP) (X109) and (X108) are standard DP ports.

For the pin assignment of the DP connector, see Chapter 12.1.4: Display Port Connectors (X109, X108).

4.1.8. Serial Ports (X111, X110)

The two serial ports (X111) and (X110) are RS232/422/485 configurable in the BIOS setup menu. For the pin assignment of the serial ports, see Chapter 12.1.5: Serial Port Connectors (X111, X110).

4.1.9. Antenna (Ant.1, Ant.2, Ant.3) (option)

The three antennas connect internally to the wireless options Wi-Fi/Bluetooth and/or cellular LTE (4G) and 5G. For more information, see Chapter 5.3: Wireless Expansion Options.

4.1.10. System Expansion I/O Door (X201)

The system expansion I/O door supports one of the factory installed I/O expansion options. For more information regarding the system expansion I/O door options, see Chapter 5.4: System Expansion I/O Door.



It is only possible to implement one of the system expansion options in the I/O door.

4.2. Rear Side

The rear side features two-threaded openings used to mount a DIN Rail clamp or book mount bracket.

Figure 4: Rear Side

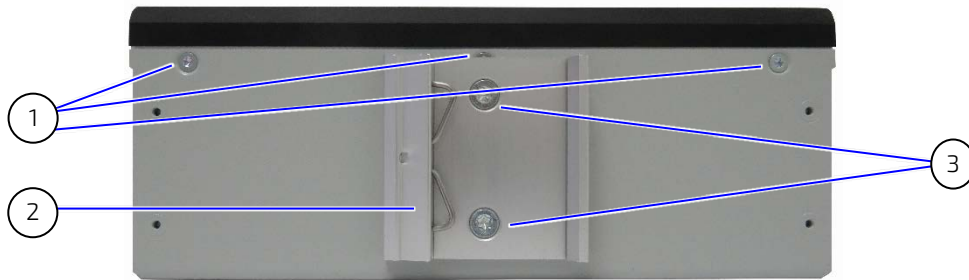

- | | | | |
|---|--|---|-----------------------|
| 1 | Three screws securing the Heatsink-Front panel assembly. | 2 | DIN Rail clamp |
| | | 3 | DIN Rail clamp screws |



The rear and bottom side DIN Rail clamps are not interchangeable due to a difference in size.

4.3. Bottom Side

The bottom side features two-threaded openings used to mount a DIN Rail clamp or book mount bracket.

Figure 5: Bottom Side

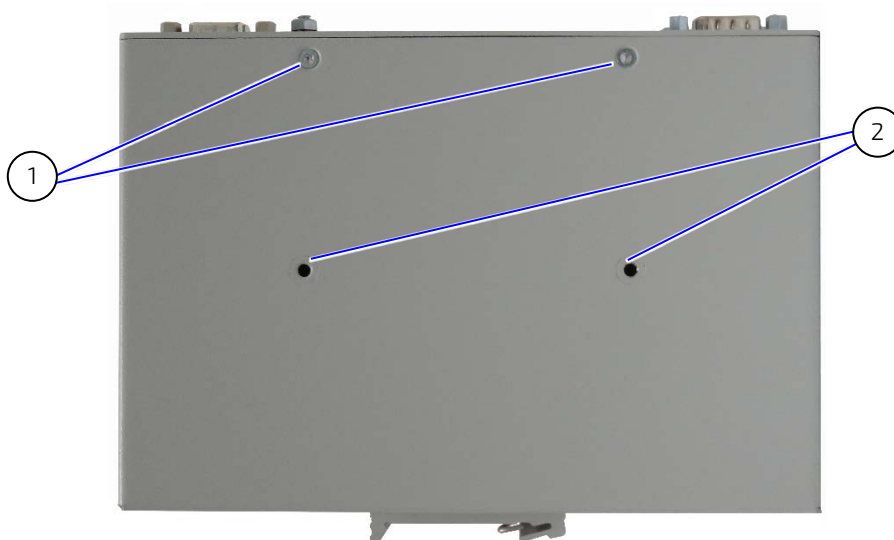

- | | | | |
|---|--|---|-----------------------------------|
| 1 | Two screws securing the Heatsink-front-panel assembly. | 2 | DIN Rail clamp mounting openings. |
|---|--|---|-----------------------------------|



The rear and bottom side DIN Rail clamps are not interchangeable due to a difference in size.

4.4. Top Side

The top side features a heatsink.

Figure 6: Top Side



Hot Surface

The heatsink can get very hot. To avoid burns and personal injury when handling the heatsink:

- Do not touch while in operation
- Allow to cool before handling
- Wear protective gloves

Surface chaude

Le dissipateur thermique peut devenir très chaud. Pour éviter les brûlures et les blessures lors de la manipulation du dissipateur thermique :

- Ne pas toucher pendant le fonctionnement
- Laisser refroidir avant la manipulation
- Portez des gants de protection

4.5. Right and Left Sides

The right and left sides feature no operational parts.

Figure 7: Left and Right Sides



1 Screws securing heatsink-front panel assembly

2 Type label (left side)

4.6. Internal Features

This chapter describes internal features relevant to the operation of the product.

Figure 8: Internal Components Example

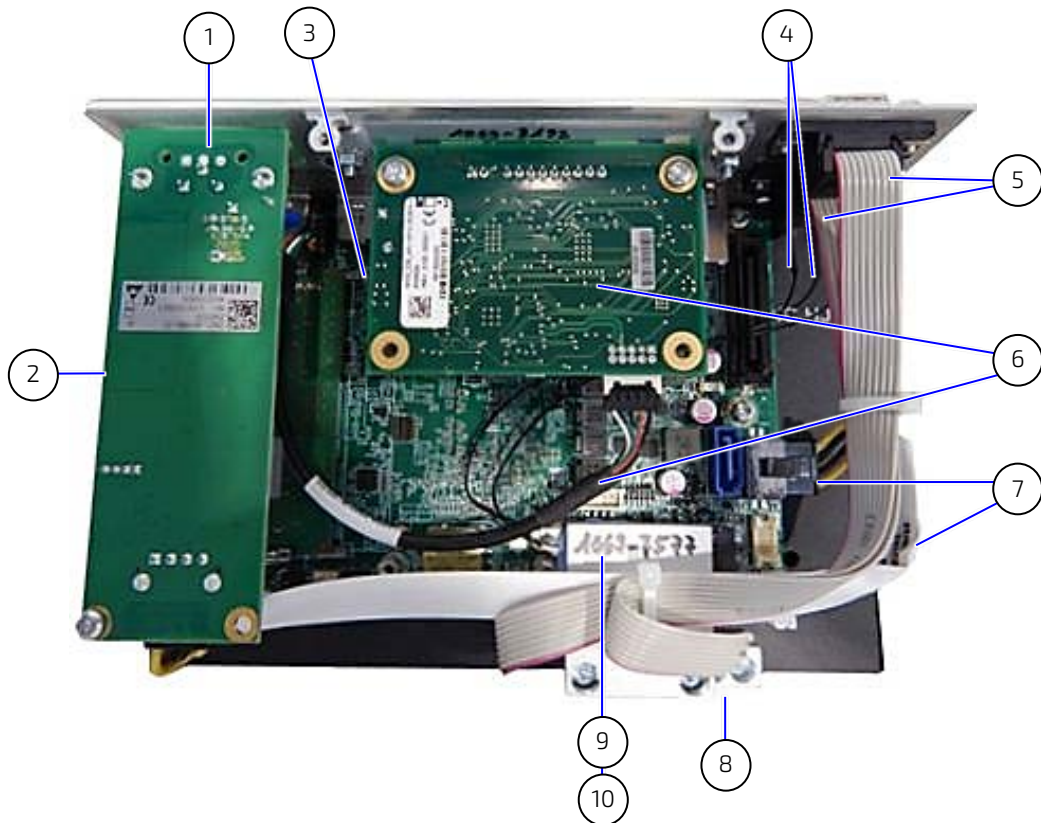

- | | | | |
|---|---|----|--|
| 1 | 12 VDC power board | 6 | Optional: I/O door implementation |
| 2 | DIMMS (not visible positioned under number 1) | 7 | Motherboard 12 V power header and cable |
| 3 | Lithium battery (not visible positioned under number 6) | 8 | Cool adapter base |
| 4 | Antenna cables | 9 | M.2 key B 3042 LTE or M.2 key B 3052 5G assembly |
| 5 | Serial ports | 10 | M.2 Key E 2230 Wi-Fi module assembly |

NOTICE

Protection label

The product is factory configured to meet customer requirements and then sealed with a protection label. Opening the product invalidates the warranty and may cause damage to internal components.

4.6.1. 3.5" SBC On-board Components

Figure 9: Top Side On-board Components

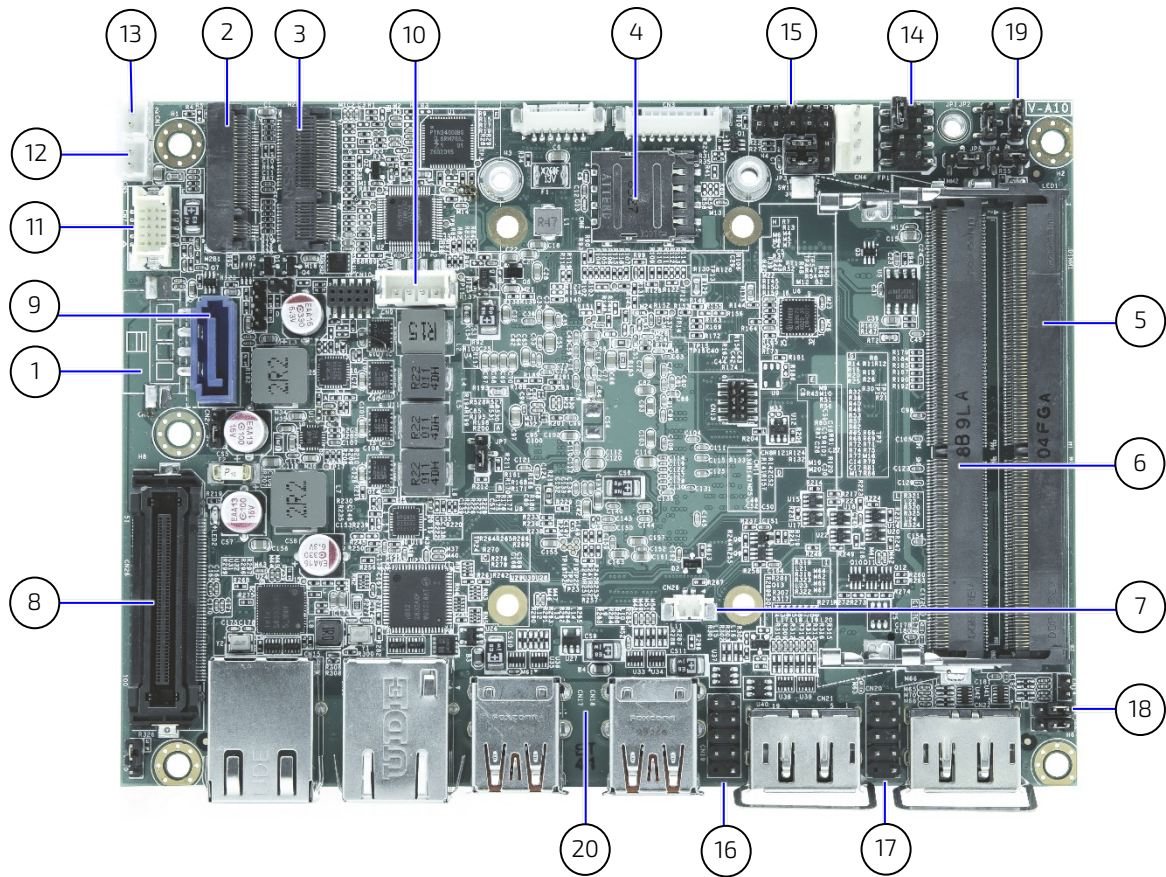

- | | | | |
|----|--|----|---------------------------------------|
| 1 | +12 V DC power input header (not shown here) | 11 | Audio Input/Output Header |
| 2 | M.2 Key B 2242 / 3042 / 2280 socket | 12 | Right channel audio AMP output header |
| 3 | M.2 Key E 2230 socket | 13 | Left channel audio AMP output header |
| 4 | Micro SIM card holder | 14 | Front panel header FP1 |
| 5 | DIMM1 DDR4 Channel 0 SO-DIMM slot | 15 | Front panel header FP2 |
| 6 | DIMM2 DDR4 Channel 1 SO-DIMM slot | 16 | USB 2.0 port headers 5, 6 |
| 7 | RTC Power input header | 17 | USB 2.0 port headers 7, 8 |
| 8 | Extended B2B connector | 18 | Clear CMOS selection jumper |
| 9 | SATA port 0 | 19 | M.2 Key B selection jumper |
| 10 | SATA power output header | 20 | USB power selection jumper |



For more information regarding the 3.5" SBC's on-board connectors, headers and jumpers, visit <https://www.kontron.com/en/products/3.5--sbc-tgl>.

Figure 10: Bottom Side On-board Components

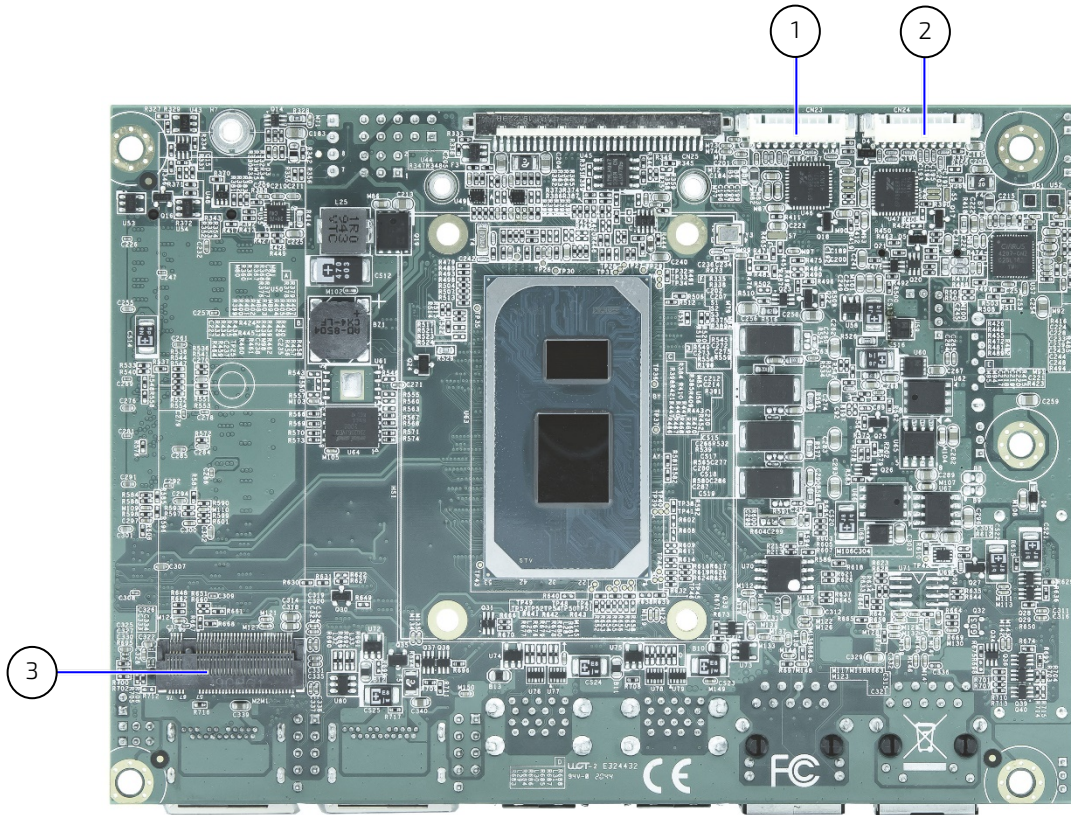

- 1 Serial Port RS232/422/485 (COM2)
- 2 Serial port RS232/422/485 (COM1)
- 3 M.2 Key M 2280 Slot



For more information regarding the 3.5" SBC's on-board connectors, headers and jumpers, visit <https://www.kontron.com/en/products/3.5--sbc-tgl>.

5/ System Expansion

5.1. Before Expanding

Before expanding users must consider the product's maximum allowed power consumption, possible space limitations within the chassis and take cooling into consideration.

The KBox A-151-TGL expansion options are factory installed and are not accessible in the field, the product must always be returned to Kontron to replace or install the expansion options described in this chapter. To return the product to Kontron, see Chapter 15.1: Returning Defective Merchandise.

Kontron supports the use of Kontron reference Internal M.2 modules, see Table 5: Storage Expansion Options and Table 6: Wireless Expansion Options, and additionally one of the system expansion I/O door options, see Chapter 5.4: System Expansion I/O Door Options.

NOTICE

Protection label

The product is factory configured to meet customer requirements and then sealed with a protection label. Opening the product invalidates the warranty and may cause damage to internal components.

NOTICE

The internal components are not accessible in the field. For replacement or installation, the product must be returned to Kontron, see Chapter 15.1: Returning Defective Merchandise.



When designing in critical internal components, cooling must be taken into consideration.

5.2. Storage Expansion Options

The storage expansion option M.2 Key M 2280 SSD module is factory installed. The module is not accessible in the field, the product must always be returned to Kontron for replacement or installation.

NOTICE

The internal components are not accessible in the field. For replacement or installation the product must be returned to Kontron, see Chapter 15.1: Returning Defective Merchandise.

Table 5: Storage Reference Options

Socket	Reference Modules
M.2 Key M 2280	Module: M.2 Key M with NVMe/SSD Density: 128 GB, 256 GB, 512 GB and 1 TB Interface: PCIE x4 Type: 3D NAND TLC Features: Power Loss protection, PE Cycle Min 3000

5.3. Wireless Expansion Options

The wireless expansion options M.2 Key E (Wi-Fi) and M.2 Key B (LTE (4G) or 5G) modules are factory installed. The module(s) are not accessible in the field, the product must always be returned to Kontron for replacement or installation.

NOTICE

The internal components are not accessible in the field. For replacement or installation the product must be returned to Kontron, see Chapter 15.1: Returning Defective Merchandise.



When designing in critical internal components, cooling must be taken into consideration.

Table 6: Wireless Reference Options

M.2 Socket	M.2 Socket Interface	Function	Reference Modules	
M.2 Key E 2230	PCIe – Wi-Fi USB 2.0 - BT	Wi-Fi/ Bluetooth	Module: Socket Type: IEEE Standards: Bluetooth standard: Power consumption: MIMO Support: Security levels: Antenna Connector:	Wi-Fi 6E 2x2 160 MHz channel bandwidth (2.4 Gbps) M.2 Key E 2230 Wi-Fi: 802.11a/b/g/n/ac R2/ax R2(Pre-Standard) V5.2 3 W 2x2 MIMO WPA, WPA2, WPA3 SMA male (hinged)
M.2 Key B 2242 / 3042 / 2280	USB 2.0	LTE (4G)	Module: Socket Type: Freq. Bands: Power consumption: MIMO Support: Antenna:	LTE Cat. 4 (150 Mbit/s Download; 50 Mbit/s Upload) M.2 Key B 3042 B1/B3/B7/B8/B20/B28/B38/B41 (Europe) 3.14 W Yes SMA male (hinged)
	PCIe 3.0	5G	Module: Socket type: Freq. Bands: Power Consumption: MIMO Support: Antenna:	5G Sub-6G Module M.2 Key B 3052 n1, n2, n3, n5, n75, n85, n125, n205, n255, n28, n385, n405, n41, n485, n66, n71, n77, n78, n79 31.6 mA (NR bands - standby current) 2x2 DL MIMO (all bands) SMA male (hinged)
SIM slot			SIM interface is required for cellular LTE (4G) and 5G modules.	

5.4. System Expansion I/O Door

The system expansion I/O door supports one of the factory installed I/O expansion options.

5.4.1. Audio Line-out (option)

The audio line-out expansion option supports one Jack connector for use with a 3.5 mm stereo audio jack to enable the connection of external active speakers and headphones, or other output devices.

For the pin assignment of the audio line-out jack, see Chapter 12.2.1: Audio Line-out Connector (option).

5.4.2. Dual CAN Bus (option)

The dual CAN bus expansion option supports two CAN bus 2.0B ports that are backwards compatible with Can bus 2.0A and meeting the requirements of ISO 11898-1.

Further CAN bus features are:

- ▶ Support for baud rates of 10/20/50/100/250/500/800/1000K
- ▶ Support for CAN message acceptance filter
- ▶ Support for J1939/CAN open high layer protocol

For the pin assignment of the Dual CAN Bus ports, see Chapter 12.2.2: Dual CAN Bus Connectors (option).



Prerequisite: Motherboards M.2 2280 B socket is not populated with a different M.2 module.

5.4.3. Dual LAN (option)

The dual LAN expansion option supports two GbE LAN ports with speed and activity indication LEDs.

For the pin assignment of the Dual LAN ports, see Chapter 12.2.4: Dual LAN Connectors (option).



Prerequisite: Motherboards M.2 2280 B socket is not populated with a different M.2 module.

5.4.4. Dual RS232 Serial Ports (option)

The dual RS232 expansion option supports two RS232 serial outputs.

For the pin assignment of the Dual RS232 ports, see Chapter 12.2.5: Dual RS232 Serial Port Connectors (option).

5.4.5. Dual EtherCAT (option)

The dual EtherCAT expansion option supports two RJ45 EtherCat ports with Auto Crossover and switching between RX and TX.

For the pin assignment of the Dual EtherCAT ports, see Chapter 12.2.3: Dual EtherCAT Connectors (option).

NOTICE

The EthererCAT RJ45 connectors may only be used for LAN. Use for telecommunications is not possible.



Prerequisite: Motherboards M.2 2280 B socket is not populated with a different M.2 module.

5.4.6. 8-Channel GPIO/DIO (option)

The expansion slot option supports eight GPIO bi-directional digital IO signals, where each GPIO can be selected as an output or an input channel. For the GPIO/DIO connector pin assignment, see Chapter 12.2.6: 8-Channel GPIO/DIO Connector (option).

The GPIO input and output specification supports the following:

Table 7: GPIO Input and Output Channels

GP Input Channel	Description	GP Output Channel	Description
Input Type	Input with integrated Pulldown	Output Type	High side switch
Input Voltage	10 VDC to 30 VDC ^[1]	Output Voltage	10 VDC to 30 VDC
Input Pulldown Resistor	20 kOhm approx.	Output Current	250 mA (500 mA max.)
Input High Level	>8.8 V	Inductive load switch-off energy dissipation	40 mJ
Input Low Level	<4.2 V	Output Protection	Short to GND protection by current limit Thermal shutdown with output auto-retry Inductive Load negative Voltage Clamp
Input Hysteresis	>2.5 V		

^[1] Maximum allowed input voltage depends on external connected voltage at PWR_IN. (GPIOx ≤ PWR_IN)

Figure 11: Output Application Connected to GPIO

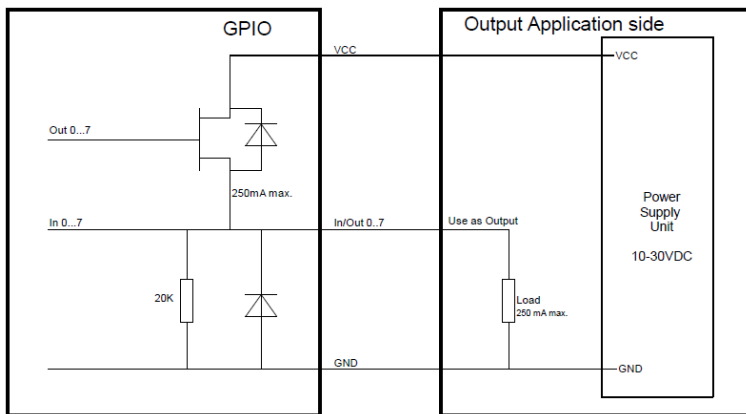
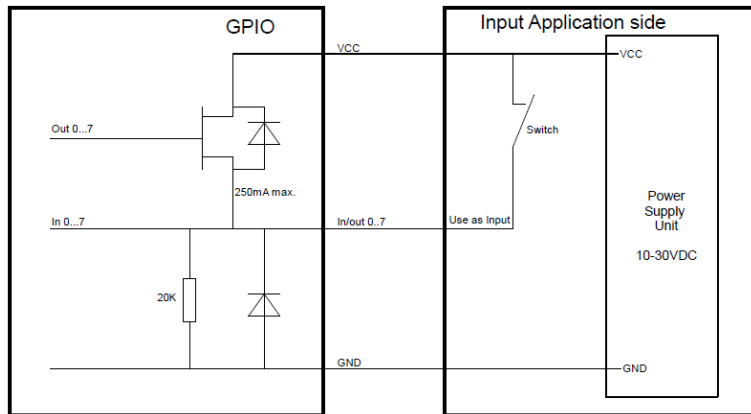

Figure 12: Input Application Connected to GPIO



5.4.7. Dual LAN and Dual DP (option)

The dual LAN and dual DP expansion option supports two 2.5 GbE RJ45 LAN ports with speed and activity indication LEDs and two DP ports.

For the pin assignment of the Dual LAN ports and DP port, see Chapter 12.2.7: Dual LAN and Dual DP Connectors (option).

6/ Thermal Management

6.1. Passive Cooling

The KBox A-151-TGL is passively cooled and fanless, using a heatsink. The critical internal components are directly connected to the outer chassis to optimize heat transfer. The heatsink on the top side can get very hot and precautions must be taken before handling or touching.

Do not obstruct the airflow around the heatsink as this may cause a build-up of heat. Observe a minimum clearance distance around the product.

6.2. Heatsink

The heatsink (180 mm x 123 mm) is located on the top side. For additional heatsink mechanical information, see Chapter 11.6: Mechanical Specification.



Hot Surface

The heatsink can get very hot. To avoid burns and personal injury when handling the heatsink:

- Do not touch while in operation
- Allow to cool before handling
- Wear protective gloves

Surface chaude

Le dissipateur thermique peut devenir très chaud. Pour éviter les brûlures et les blessures lors de la manipulation du dissipateur thermique :

- Ne pas toucher pendant le fonctionnement
 - Laisser refroidir avant la manipulation
 - Portez des gants de protection
-

6.3. Mount Orientation

When mounting the product onto the control cabinet take care not to obstruct the airflow over the heatsink, as this can stop sufficient heat dissipating into the ambient environment and cause a build-up of heat. Kontron provides a DIN Rail clamps and a book mount bracket, individually mountable on the product's rear side or bottom side. For more information, see Chapter 8/ Installation.

6.4. Minimum Clearance

To provide maximum airflow away from the heatsink a minimum clearance distance of 12 mm (0.47 inch) to the surrounding environment must be observed, also known as keep out area in this user guide. The specified keep out areas for the product when mounted horizontally and vertically differ. For more information, see Chapter 8.4: Clearance.

⚠ CAUTION

Leave a sufficient clearance (keep out area) of to prevent the product from overheating!
To ensure proper operation observe the heatsink's specified minimum clearance of 12 mm (0.47 inch).

6.5. Third Party Components

When extended and configured with additional third party components, users must take into account that the air temperature inside the product is higher than the ambient temperature. An approximate internal temperature rise occurs. To avoid overheating users must include an adequate cooling solution for the additional third party components to absorb the heat produced by the additional internal third party components and transfer the heat out of the product.



The maximum system ambient temperature depends mostly on the power consumption of the processor, chipset and third party components.

6.6. Maximum Processor Temperatures

As the Intel® processors provide only certain settings for maximal power consumption some typical values are given below, as a guideline.

Table 8: Maximum Processor Temperatures

Processor	TDP	Operating Temperature (range)
11th Gen. Intel® Core u-Series/Celeron®		
Intel® Core™ i3-1115G4E Dual Core, 6 MB Cache, 2.2 GHz, up to 3.9 GHz (Turbo)	15W	0°C to 100°C (32°F to 212°F)
Intel® Celeron® 6305E Dual Core, 4 MB Cache, 1.8 GHz	15W	0°C to 100°C (32°F to 212°F)
Intel® Core™ i5-1145GRE Quad Core, 8 MB Cache, 1.5 GHz, up to 4.1 GHz (Turbo)	15W	-40°C to 100°C (-40°F to 212°F)
Intel® Core™ i7-1185GRE Quad Core, 12 MB Cache, 1.8 GHz, up to 4.4 GHz (Turbo)	15W	-40°C to 100°C (-40°F to 212°F)
Intel® Core™ i5- 1145G7E Quad Core, 8 MB Cache, 1.5 GHz, up to 4.1 GHz (Turbo)	15 W	0°C to 100°C (32°F to 212°F)
Intel® Core™ i7- 1185G7E Quad Core, 12 MB Cache, 1.8 GHz, up to 4.4 GHz (Turbo)	15 W	0°C to 100°C (32°F to 212°F)

Embedded Processor (E Type): with Tjunction limits the max. temperature range during operation is +/-70°C starting from boot time temperature.



Industrial Processor (GRE) Type: within Tjunction limits the max. temperature range during operation is +/-90°C starting from boot time temperature .

The behavior is known by Intel as Dynamic Temperature Range (DTR). For more information or a higher DTR-value, contact Kontron Support.

7/ Assembly

7.1. Before Assembling

The KBox A-151-TGL is factory configured to meet customer requirements and then sealed with a protection label. No customer assembly of M.2 expansion slots is required before operation. The M.2 expansion slots are not accessible in the field, the product must always be returned to Kontron to replace the M.2 module(s).

NOTICE

Protection label

The product is factory configured to meet customer requirements and then sealed with a protection label. Opening the product invalidates the warranty and may cause damage to internal components.

7.2. Opening the Product

Opening the product invalidates the warranty and may cause damage to internal components. If required to open the product observe the safety instructions in Chapter 2/: General Safety Instructions, the procedures and instructions within this chapter, and consult the documentation provided by the components manufacturer.

⚠ WARNING

Before opening the product, the product must be switched off using the power button, and all peripheral devices disconnected. Disconnect the product by removing the power cable from the Power IN connector or the DC power supply.

⚠ WARNING

Operated in closed condition only

It is only ensured that users do not have access to internal components during operation if the product is closed and secured.

⚠ CAUTION

Handling and operation of the product is permitted only for trained personnel aware of the associated dangers, within a work place that is access controlled and fulfills all necessary technical and environmental requirements.



Hot Surface

The heatsink can get very hot. To avoid burns and personal injury when handling the heatsink:

- Do not touch while in operation
- Allow to cool before handling
- Wear protective gloves

Surface chaude

Le dissipateur thermique peut devenir très chaud. Pour éviter les brûlures et les blessures lors de la manipulation du dissipateur thermique :

- Ne pas toucher pendant le fonctionnement
- Laisser refroidir avant la manipulation
- Portez des gants de protection

NOTICE

Protection label

The product is factory configured to meet customer requirements and then sealed with a protection label. Opening the product invalidates the warranty and may cause damage to internal components.

NOTICE

The internal 3.5" SBC contains components on both sides that can easily be damaged if handled without reasonable care, resulting in malfunction or no function at all.

**ESD Sensitive**

Follow the safety instructions for components that are sensitive to electrostatic discharge (ESD). Failure to observe this warning notice may result in damage to the product or/and internal components.

To open the product, perform the following:

1. Close all applications. Shut down properly using the power button and disconnect the power cable from the Power IN connector or the DC power supply. Disconnect all peripherals.
2. Allow the product to cool before handling and do not touch the heatsink until the heatsink has cooled.

**Hot Surface**

Heatsink can get very hot. To avoid burns and personal injury:

- Do not touch the heatsink when the product is in operation
- Allow the product to cool before handling
- Wear protective gloves

Surface chaude

Les dissipateurs thermiques peuvent devenir très chauds. Pour éviter les brûlures et les blessures corporelles :

- Ne pas toucher le dissipateur de chaleur lorsque le produit est en fonctionnement.
- Laissez le dissipateur thermique refroidir avant de manipuler le produit.
- Portez des gants de protection.

3. Place on a flat, clean and ESD-safe surface with the top side facing upwards.
4. Remove the two screws on the bottom side of the product.



5. Removed the one screw on the right and left sides of the product.



- Remove the DIN Rail clamp if attached and then remove the three screws on the rear side of the product.



- Lift the heatsink-front panel assembly vertically upwards, while taking care not damage internal components or to disconnect any cables. Place the heatsink-front panel assembly with the heatsink facing downward on an ESD-safe surface.



- Close the product, by proceeding in the reverse order.

7.3. Removing or installing a M.2 Module

The factory installed M.2 modules (SSD, Wi-Fi/Bluetooth, LTE and 5G) are not accessible in the field, the product must always be returned to Kontron to replace the module(s), see Chapter 15.1: Returning Defective Merchandise.

CAUTION

Wi-Fi/Bluetooth, LTE and 5G operation is only supported with an intact cool adapter.

Protection label

NOTICE

The product is factory configured to meet customer requirements and then sealed with a protection label. Opening the product invalidates the warranty and may cause damage to internal components.

NOTICE

The internal components are not accessible in the field. For replacement or installation the product must be returned to Kontron, see Chapter 15.1: Returning Defective Merchandise.



If changed, the partitioning of the M.2 SSD module memory may differ and require repartitioning.

8/ Installation

8.1. Before Installing

Before installing the KBox A-151-TGL in the operating environment, ensure that the operating environment meets the specification stated within this user guide, and that there is sufficient access to the Power IN connector and the front panel I/O connectors.

Kontron recommends expanding the product, before installing the product in the end environment.

▲ CAUTION

Ensure Sufficient Airflow.

Operate only in a well-ventilated environment that does not obstruct the airflow over the heatsink or obstruct the product from dissipating heat.

▲ CAUTION

Do not place the product close to heat sources or damp places.

8.2. Control Cabinet Mounting

8.2.1. DIN Rail

To install the product in an industrial control cabinet, mount a DIN Rail clamp on the rear side or bottom side of the product, see Table 2: Accessories. The DIN Rail clamps are not interchangeable due to a difference in size.

Figure 13: DIN Rail Clamp (rear side and bottom side)

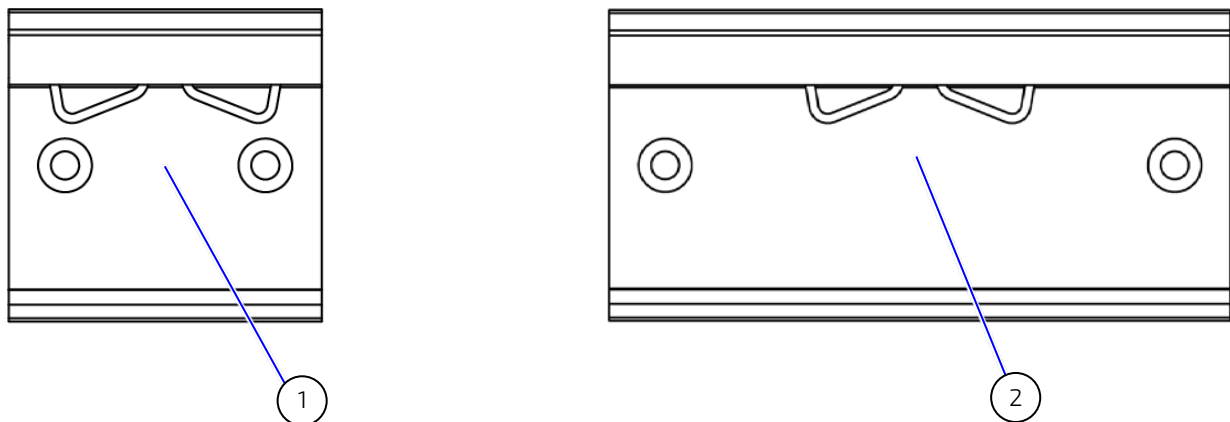

1 DIN Rail clamp rear side
(50 mm x 50 mm)

2 DIN Rail clamp bottom side
(50 mm x 100 mm)



The rear and bottom side DIN Rail clamps are not interchangeable due to a difference in size.

To attach the DIN Rail clamp, perform the following:

1. Fasten the DIN Rail clamp firmly using the supplied two M4x6 screws only.
2. Clip the top of the DIN Rail clamp onto the DIN Rail and push the bottom of the DIN Rail clamp firmly until the DIN Rail clamp attaches to the bottom of the DIN Rail.

8.3. Book Mount Bracket

To install the product on a flat mounting surface, fix the book mount bracket on the rear side or bottom side, see Table 2: Accessories.

Figure 14: Book Mount Bracket

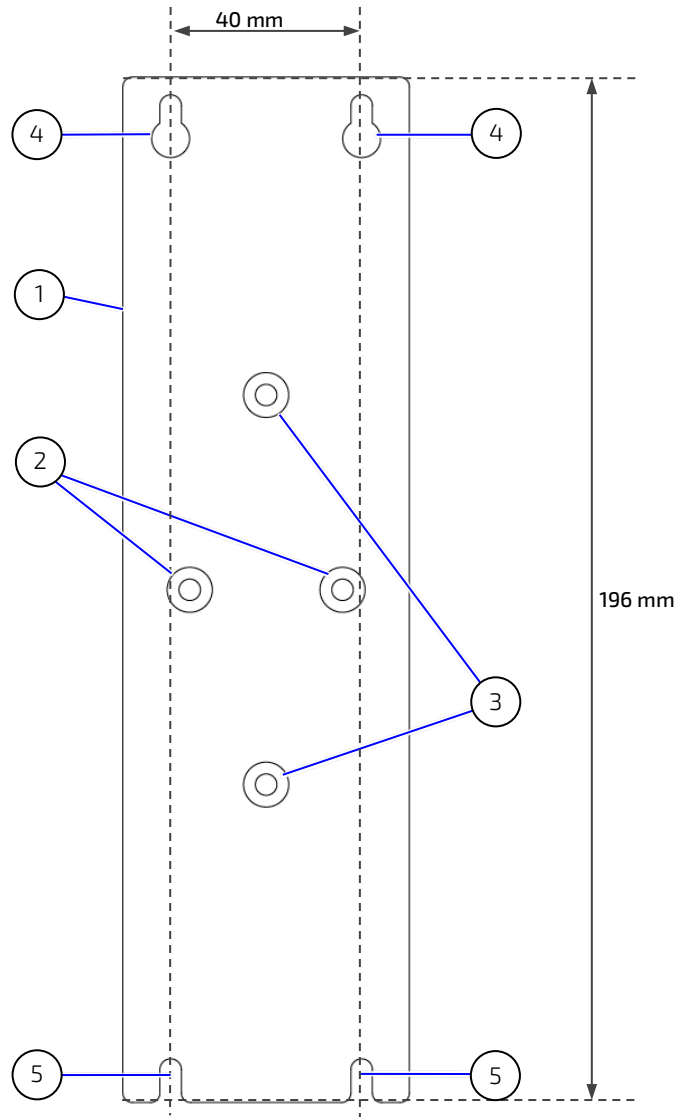

- | | | | |
|---|---|---|--|
| 1 | Book mount bracket | 3 | 2x M4x6 screws openings
(mounting on the bottom side) |
| 2 | 2x M4x6 screws opening
(mounting on the rear side) | 4 | 2x Key holes upper mounting bracket |
| | | 5 | 2x Key holes lower mounting bracket |

To attach the book mount bracket to install on a flat surface, perform the following:

1. Attach the book mount bracket (Figure 14, pos. 1) firmly to the rear side or bottom side of the product using the designated openings (Figure 14, pos. 2 or pos.3). secure using the two screws (M4x6 Torx) supplied with the bracket and a thread locking compound.

- Attach to a flat surface with a minimum thickness of 3 mm and made of aluminum or better using four (M4x8, steel 4.8, DIN 7985/ISO 7045 or similar) screws. Always use all four key holes (Figure 14, pos. 4 and pos. 5) and a thread locking compound to secure the four screws. The four screws (Figure 14, pos. 4 and pos. 5) are to be supplied by the user as the user environment dictates the required length of the screws.

CAUTION

Mounting the Book Mount Bracket on the Mount Surface

- Always use four screws (M4x8, steel 4.8, DIN 7985/ISO 7045 or similar).
- The length of the four screws depends on the thickness of the mounting surface.
- Mount on a surface with a minimum thickness of 3 mm and made of aluminum or better.

8.4. Clearance

For sufficient air circulation around the product, Kontron recommends users not to mount or operate any other devices within the specified keep out areas around the product. The specified keep out areas for the product are displayed in Figure 15: Keep Out Areas- Horizontal and Figure 16: Keep Out Areas- Vertical

CAUTION

Leave a sufficient clearance (keep out area) of to prevent the product from overheating! To ensure proper operation observe the heatsink's specified minimum clearance of 12 mm (0.47 inch).

The connector keep out area on the front panel increases with the addition of antennas and depends on the type of Wi-Fi antenna used.



Cable clearance depends on the installed connector types and antennas and is typically up to 12 mm.

Figure 15: Keep Out Areas- Horizontal

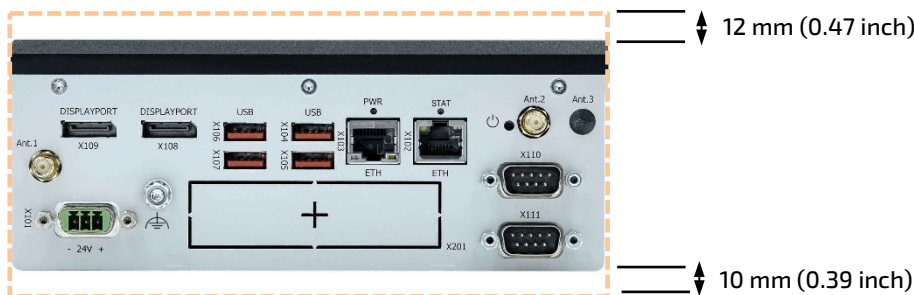

9/ Starting UP

9.1. Before Starting

Before connecting the KBox A-151-TGL to power, read the instructions in this user guide and observe the safety instructions in Chapter 2/General Safety Instructions.

The product comes hardware configured and on request with a pre-installed Operating System (OS) and all the necessary drivers (in accordance with the ordered hardware configuration). No further internal configuration is required, enabling full operation when connected to power and switched on for the first time.

⚠ WARNING

Operated in closed condition only

It is only ensured that users do not have access to internal components during operation if the product is closed and secured.

⚠ CAUTION

Only connect the product to an external power supply providing the voltage type (AC or DC) and the input power (max. current) specified on the Kontron Product Label and meeting the requirements of the Limited Power Source (LPS) and Power Source (PS2) of UL/IEC 62368-1.

⚠ CAUTION

Ensure that the power supply and power cables have no visible damage.

9.1.1. Wiring the Power IN Connector

The Power IN connector connects to a DC power supply using the supplied mating power connector (PSC 1.5/ 3-F) and the corresponding wiring inserted into the mating power connector's clamps (Figure 17, pos. 4, 5 & 6). Mark the supply wires (+/-) clearly to ensure a safe connection from the Power IN connector to the DC power supply.

The wiring is not part of the delivery and must be provided by the user.

- ▶ Use copper conductors only if the field wiring terminal is only for connection to copper wire.
- ▶ Minimum temperature rating of the field wiring terminals is 75° C.

Figure 17: Power IN Connector and Mating Power Connector



- | | | | |
|---|---|---|------------------------|
| 1 | 3-pin Power IN connector (PSC 1.5/ 3-M) | 4 | Clamp for earth wire |
| 2 | 3-pin mating power connector (PSC 1.5/ 3-F) | 5 | Clamp for 0 VDC wire |
| 3 | Cover over the slotted pan head screws | 6 | Clamp for +24 VDC wire |

To wire the supplied mating power connector (PSC 1.5/ 3-F), perform the following:

1. Cut three (1 mm²) AWG18 isolated wires to the required length and strip each end 5 mm to 7 mm.
2. Twist the striped wire-ends and provide them with ferrules.
3. Access the slotted pan head screws by opening the mating power connector's cover.
4. Loosen the slotted pan head screws far enough so that you can insert the end of the prepared wires.
5. Insert the wires into the corresponding clamp of the mating power connector. Make sure that you have the right polarity of the connection.
6. Fasten the screws to secure the wires into the mating power connector's clamps.
7. Close the mating power connector's cover.

NOTICE

Mark the supply wires (+/-) clearly to ensure a safe connection from the Power IN connector to the DC power supply.

NOTICE

Support the power and I/O cables to minimize the strain on the product's connectors.

9.2. Connecting to a DC Power Supply

⚠ WARNING

Operated in closed condition only

It is only ensured that users do not have access to internal components during operation if the product is closed and secured.

⚠ CAUTION

Only connect the product to an external power supply providing the voltage type (AC or DC) and the input power (max. current) specified on the Kontron Product Label and meeting the requirements of the Limited Power Source (LPS) and Power Source (PS2) of UL/IEC 62368-1.

⚠ CAUTION

Observe that wiring and short-circuit/overcurrent protection is performed according to the applicable standards, regulations and in respect to the product's electrical specification. The disconnecting device (fuse/circuit breaker) rating must be in accordance with the product wire cross-section.

⚠ CAUTION

Even when switched off using the power button, parts of the product are still energized. The product is only completely switched off when the power has been switched off using the power button and the power cable is disconnected from either the DC power supply or the Power IN connector.

NOTICE

Following a proper cabling procedure prevents a false power-on condition, that could result in operational failure. When installing/disconnecting the product ensure that:

- The functional earth connection is made first and disconnected last.
 - The last connection made to the product is the power wiring.
-

NOTICE

Mark the supply wires (+/-) clearly to ensure a safe connection from the Power IN connector to the DC power supply.

NOTICE

Support the power and I/O cables to minimize the strain on the product's connectors.

NOTICE

Do not disconnect the power while the product is operating! This performs a forced shutdown and can lead to loss of data. To shutdown without data loss, switch off using the power button.

To connect to the external DC power supply, perform the following:

1. Wire the supplied mating power connector/terminal (PSC 1.5/3-F) as described, see Chapter 9.1.1: Wiring the Power IN Connector.
2. Switch off the external DC power supply via a disconnecting device (fuse/circuit breaker), to ensure that no power flows during the connection procedure.
3. Connect the functional earth bolt to an appropriate common earth connection.
4. Connect the wired mating power connector (PSC 1.5/3-F) to the Power IN connector. Pay attention to the polarity of the connections.
5. Connect the other end of the wired mating power connector to the external DC power supply.

9.3. Switching On/Off

Once connected to an external DC power supply the product can be switched on and switched off using the power button. To switch on, press the power button and to switch off, press the power button again to perform an orderly shut down.

CAUTION

Even when switched off using the power button, parts of the product are still energized. The product is only completely switched off when the power has been switched off using the power button and the power cable is disconnected from either the DC power supply or the Power IN connector.

NOTICE

Do not disconnect the power while the product is active. This performs a forced shutdown and can lead to loss of data. To shutdown properly without data loss, switch off using the power button.

9.4. Operating System (OS) and Drivers

If ordered with a pre-installed operating system, all drivers are installed in accordance with the ordered configuration and the product is operational, when switched on for the first time.

If ordered without a pre-installed operating system, users will need to install the operating system and the appropriate drivers for the configuration ordered.



To download relevant drivers for the factory installed hardware components, visit Kontron's EMD customer section: <https://emdcustomersection.kontron.com>.



Pay attention to the manufacturer's OS specifications relating to the integrated hardware components.

10/ BIOS

The KBox A-151-TGL uses the AMI Aptio V uEFI BIOS based on the Unified Extensible Firmware Interface (uEFI) specification and the Intel® Platform Innovation Framework for EFI. The uEFI BIOS preferences are preset and do not require further adjustment for operation.

The UEFI BIOS setup menus and available selections may vary. For specific information on the BIOS for your product, contact [Kontron Support](#).



UEFI only! No legacy support and no Master Boot Record (MBR) installation.



The uEFI BIOS features listed in this user guide are open to change and may not be available in the latest version of the uEFI BIOS. For the latest uEFI BIOS Information, visit [Kontron's Customer Section](#).



For more information regarding the uEFI BIOS and its special settings, visit <https://www.kontron.com/en/products/3.5--sbc-tgl>, to download the 3.5"-SBC-TGL user guide.

10.1. Starting the uEFI BIOS

The uEFI BIOS's Setup program provides quick and easy access to the individual function settings for control or modification of the uEFI BIOS configuration. The Setup program allows for access to various functions that include sub-menus with further functions and sub-menus.

To start the uEFI BIOS Setup program, follow the steps below:

1. Switch on the product.
2. Wait until the first characters appear on the screen (POST messages or splash screen).
3. Press the key.
4. If the uEFI BIOS is password-protected, a request for password will appear. Enter either the User Password or the Supervisor Password, press <RETURN>, and proceed with step 5.
5. The BIOS setup utility appears in the Main menu.

Using the hot key navigation system, users can navigate through the BIOS. The hot key legend bar is located at the bottom of the Setup screens. For a list of navigation hot keys available in the legend bar, see Table 9: Navigation Hot Keys Available in the Legend Bar.

Table 9: Navigation Hot Keys Available in the Legend Bar

Sub-screen	Description
<F1>	<F1> key invokes the General Help window
<->	<Minus> key selects the next lower value within a field
<+>	<Plus> key selects the next higher value within a field
<F2>	<F2> key loads previous values
<F3>	<F3> key loads optimized defaults
<F4>	<F4> key Saves and Exits
<←> or <↔>	<Left/Right> arrows selects major Setup menus on menu bar, for example, Main or Advanced

Sub-screen	Description
<↑> or <↓>	<Up/Down> arrows select fields in the current menu, for example, Setup function or sub-screen
<ESC>	<ESC> key exits a major Setup menu and enters the Exit Setup menu Pressing the <ESC> key in a sub-menu displays the next higher menu level
<RETURN>	<RETURN> key executes a command or selects a submenu

10.2. Setup Menus

The Setup utility features menus listed in the selection bar at the top of the screen are:

- ▶ Main
- ▶ Advanced
- ▶ Power
- ▶ Boot
- ▶ Security
- ▶ Save & Exit

The current active menu and active BIOS Setup item are highlighted in white. Use the left and right arrow keys to select the Setup menus.

Each Setup menu is made up of two main frames. The left frame displays all available functions. Configurable functions are displayed in blue. Functions displayed in grey provide information about the status or the operational configuration. The right frame displays an explanation of the respective function in a help window.



The following BIOS setup menus are examples for a specific product configuration. Features in grey maybe be hidden within the BIOS setup and other features may differ.

10.3. Main Setup Menu

Upon entering the uEFI BIOS Setup program, the Main Setup menu is displayed. This screen lists the Main Setup menu sub-screens and provides basic system information. Additionally, functions for setting the system time and date are offered.

The Main Menu provides an overview of the system information and enables users to set the System date and time.

Figure 18: Main Setup Menu Example

Aptio Setup - AMI					
Main	Advanced	Power	Boot	Security	Save & Exit
Product Information					
Product Name	3.5-SBC-TGL				
BIOS Version	TGLUVEXY.003 (x64)				
BIOS Build Date	11/29/2022				
ME Firmware Version	15.0.30.1776 (Corporate)				
CPU Information					
11 th Gen Intel® Core™ i5-1145G7E @ 2.6GHz					
Microcode Revision	9A				
Processor Cores	4 Core(s) / 8 Threads(s)				
Memory Information					
Total Size	4096 MB (DDR4)				
Frequency	3200 MHz				
Board Information					
UUID	737AC850-2C5A-11B2-8001 0050080E9370		→ ←: Select Screen		
Serial #	00000000		↑ ↓: Select Item		
LAN1 MAC Address	00:50:08:0E:93:70		Enter: Select		
LAN2 MAC address	00:50:08:0E:93:71		+/-: Change Opt.		
System Date	[Mon 03/20/2023]		F1: General Help		
System Time	[08:03:37]		F2: Previous Values		
Access Level	Administrator		F3: Optimized Defaults		
			F4: Save & Reset		
			ESC: Exit		
Version 2.21.1278 Copyright (C) 2022 AMI.					

10.4. Advances Setup Menu

Figure 19: Advances Setup Menu Example

Aptio Setup - AMI					
Main	Advanced	Power	Boot	Security	Save & Exit
HD Audio		[Enabled]			
Onboard LAN1 Controller		[Enabled]			
Onboard LAN2 Controller		[Enabled]			
Load I225 UNDI Driver		[Disabled]			
Load I210 UNDI Driver		[Disabled]			
> Display Configuration					
> CPU Chipset Configuration					
> NVMe Configuration					
> SATA Configuration					
> USB Configuration					
> AMT Configuration					
>Trusted Computing					
> DIO Configuration					
> Network Stack					
> Super I/O Configuration					
> H/W Monitor					
				→ ←: Select Screen	
				↑ ↓: Select Item	
				Enter: Select	
				+/-: Change Opt.	
				F1: General Help	
				F2: Previous Values	
				F3: Optimized Defaults	
				F4: Save & Reset	
				ESC: Exit	
Version 2.21.1278 Copyright (C) 2022 AMI.					

The following table gives more information about important setup options within the Advanced Menu. Default settings are displayed in **bold**.

Table 10: Advanced Setup Menu Sub-screens and Functions

Sub-screen	Additional Sub-screens with Description
HD Audio	[Enabled , Disabled]
Onboard LAN 1 Controller	[Enabled , Disabled]
Onboard LAN 2 Controller	[Enabled , Disabled]
Load Intel I225 UNDI	[Disabled , Enabled]
Load Intel I210 UNDI	[Disabled , Enabled]

Sub-screen	Additional Sub-screens with Description	
Display Configuration>	Aperture Size	[128MB, 256MB , 512MB, 1024 MB, 2048 MB]
	DVMT Pre-Allocated	[32M; 64M ; 4M; 8M; 12M; 16M; 20M; 24M; 28M; 32M/F7; 36M; 40M; 44M; 48M; 52M; 56M; 60M;]
	DVMT Total Gfx Mem	[128M, 256M , MAX]
	Active LVDS	[Enabled, Disabled]

Sub-screen	Additional Sub-screens with Description	
CPU Chipset Configuration>	Intel® SpeedStep™	[Enabled, Disabled]
	Turbo Mode	[Enabled, Disabled]
	Hyper-Threading	[Enabled, Disabled]
	VT-d	[Enabled, Disabled]
	Active Processor Cores	[All , 1, 2, 3]
	Configure TDP Mode	[28 W, 15 W , 12 W]
	Intel (VMX) Virtualization Technology	[Enabled, Disabled]
	Intel Trusted Execution Technology	[Enabled, Disabled]
	CPU CrashLog (Device 10)	[Enabled, Disabled]
	GNA Device (B0:D8:F0)	[Enabled, Disabled]
	IPU Device (B0:D5:F0)	[Enabled, Disabled]

Sub-screen	Additional Sub-screens with Description	
NvMe Configuration>	<i>Read Only Field</i> No NVMe device found	

Sub-screen	Additional Sub-screens with Description	
SATA Configuration>	SATA-Controllers(s)	[Enabled, Disabled]
	Serial ATA Port 0 (CN27)	
	Port 0	[Enabled, Disabled]

Sub-screen	Additional Sub-screens with Description	
USB Configuration>	XHCI Hand-off	[Enabled, Disabled]
	USB Mass Storage Driver Support	[Enabled, Disabled]

Sub-screen	Additional Sub-screens with Description	
AMT Configuration>	AMT BIOS Features	[Enabled, Disabled]
	Unconfigure ME	[Enabled, Disabled]

Sub-screen	Additional Sub-screens with Description	
Trusted Computing>	Firmware Version	<i>Read Only Field</i> 7.85 <i>Note: Hidden if Security device support = disabled</i>
	Vendor	<i>Read Only Field</i> IFX <i>Note: Hidden if security device support = disabled</i>
	Security Device Support	[Enabled , Disabled]
	Active PCR Banks	<i>Read only field</i> SHA256 <i>Note: Hidden if security device support = disabled</i>
	Available PCR Banks	<i>Read only field</i> SHA-1, SHA256 <i>Note: Hidden if security device support = disabled</i>
	SHA-1 PCR Bank	[Enabled, Disabled]
	SHA256 PCR Bank	[Enabled , Disabled]
	Pending Operation	[None , TPM Clear] <i>Note: Hidden if security device support = disabled</i>
	Platform Hierarchy	[Enabled , Disabled] <i>Note: Hidden if security device support = disabled</i>
	Storage Hierarchy	[Enabled , Disabled] <i>Note: Hidden if security device support = disabled</i>
	Endorsement Hierarchy	[Enabled , Disabled] <i>Note: Hidden if security device support = disabled</i>
	TPM2.0 UEFI Spec. Version	[TCG_1_2; TCG_2] <i>Note: Hidden if security device support = disabled</i>
	Physical Presence Spec.	[1.2, 1.3] <i>Note: Hidden if security device support = disabled</i>
	TPM 20 Interface Type	<i>Read only field</i> TIS <i>Note: Hidden if security device support = disabled</i>
Disable Block Sid	[Enabled, Disabled]	

Sub-screen	Additional Sub-screens with Description	
DIO Configuration>	User Configured	[Enabled, Disabled]
	Force unlock on all GPIO pads	[Enabled , Disabled]
	DIO-0	[Output Low, Output High]
	DIO-1	[Output Low, Output High]
	DIO-2	[Output Low, Output High]
	DIO-3	[Output Low, Output High]
	DIO-4	[Output Low, Output High]

Sub-screen	Additional Sub-screens with Description	
DIO Configuration>	DIO-5	[Output Low, Output High]
	DIO-6	[Output Low, Output High]
	DIO-7	[Output Low, Output High]
	DIO_0 as Input Value	[1]
	DIO_1 as Input Value	[1]
	DIO_2 as Input Value	[1]
	DIO_3 as Input Value	[1]
	DIO_4 as Input Value	[1]
	DIO_5 as Input Value	[1]
	DIO_6 as Input Value	[1]
DIO_7 as Input Value	[1]	

Sub-screen	Additional Sub-screens with Description	
Network Stack>	Network Stack	[Enabled, Disabled]
	Ipv4 PXE Support	[Enabled, Disabled] <i>Note: only if Network Stack = Enabled</i>
	Ipv6 PXE Support	[Enabled, Disabled] <i>Note: only if Network Stack = Enabled</i>

Sub-screen	Additional Sub-screens with Description		
Super IO Configuration>	Serial Port 1 Configuration >	Serial Port	[Enabled , Disabled]
		Device Settings	<i>Read only field</i> IO=3F8h; IRQ=4;
		Change Settings	[Auto IO=3F8h; IRQ=4; IO=3F8h; IRQ=3,4,5,6,7,9,10,11,12; IO=3E8h; IRQ=3,4,5,6,7,9,10,11,12; IO=2E8h; IRQ=3,4,5,6,7,9,10,11,12]
		Serial Port 1 Type	[RS232 , RS422, RS485]
		RS485 Duplex Mode	[Half Duplex , Full Duplex] <i>Note: only visible in RS485 mode</i>
		RS485 Auto Flow Control	[Disabled, Enabled] <i>Note: Only visible in RS422 / RS485 Mode. Default is Disabled.</i>
		RS485/422 Receiver Termination	[Disabled , Enabled] <i>Note: Only visible in RS422 / RS485 Mode. Default is Enabled.</i>
	Serial Port 2 Configuration>	Serial Port	[Enabled , Disabled]
		Device Settings	<i>Read only field</i> IO=2F8h; IRQ3;

Sub-screen	Additional Sub-screens with Description		
Super IO Configuration>	Serial Port 2 Configuration>	Change Settings	[Auto IO=2F8h; IRQ=3; IO=2F8h; IRQ=3,4,5,6,7,9,10,11,12; IO=3E8h; IRQ=3,4,5,6,7,9,10,11,12; IO=2E8h; IRQ=3,4,5,6,7,9,10,11,12]
		Serial Port 2 Type	[RS232 , RS422, RS485]
		RS485 Duplex Mode	[Half Duplex , Full Duplex] <i>Note: only visible in RS485 mode</i>
		RS485 Auto Flow Control	[Disabled, Enabled] <i>Note: Only visible in RS422 / RS485 Mode. Default is Disabled.</i>
		RS485/422 Receiver Termination	[Disabled , Enabled] <i>Note: Only visible in RS422 / RS485 Mode. Default is Enabled.</i>

Sub-screen	Additional Sub-screens with Description		
H/W Monitor>	<i>Read only text</i> CPU temperature PECL, System temperature, CPU fan speed, +12 V, +3.3 V, +5 V, +3VA, +VRTC		
	Smart FAN Configuration>	CPU FAN Setting	[Manual , Smart]
		Manual Duty	[255]

10.5. Power Setup Menu

Figure 20: Power Setup Menu Example

Aptio Setup - AMI					
Main	Advanced	Power	Boot	Security	Save & Exit
Power Configuration					
ACPI Sleep State		[S3 (Suspend to RAM)]			
Restore AC Power Loss		[Power On]			
Power Saving Mode		[Disabled]			
Resume Event Control					
ResumeLAN i225		[FW-MagicPacket]			→ ←: Select Screen
ResumeLAN i210		[FW-MagicPacket]			↑ ↓: Select Item
Resume By PCI-E Device		[Disabled]			Enter: Select
Resume By Ring Device		[Disabled]			+/-: Change Opt.
Resume by RTC Alarm		[Disabled]			F1: General Help
▶ Watchdog Timer Configuration					F2: Previous Values
					F3: Optimized Defaults
					F4: Save & Reset
					ESC: Exit
					F4: Save & Reset
Version 2.21.1278 Copyright (C) 2022 AMI.					

The following table gives more information about important setup options within the Power Menu. Default settings are displayed in **bold**.

Table 11: Power Setup Menu Sub-screens and Functions

Sub-screen	Additional Sub-screens with Description	
Power Configuration		
ACPI Sleep State	[Suspend Disabled, S3 (Suspend to Ram)]	
Restore AC Power LOSS	[Power Off, Power On , Last State]	
Power Saving Mode	[Disabled , EUP Enabled]	
Resume Event Control		
ResumeLan I225	[Disabled, OS-Driver, FW-MagicPacket]	
ResumeLan I210	[Disabled, OS-Driver, FW-MagicPacket]	
Resume By PCI-E Device	[Disabled , Enabled]	
Resume By Ring Device	[Disabled , Enabled]	
Resume By RTC Alarm	[Disabled , Enabled]	
WatchDog Timer Configuration>	WDT Function	[Disabled , Enabled]

10.6. Boot Setup Menu

Figure 21: Boot Setup Menu Example

Aptio Setup - AMI					
Main	Advanced	Power	Boot	Security	Save & Exit
Boot Configuration					
Full Screen LOGO Display		[Enabled]			
Setup Prompt Timeout		1			
Bootup NumLock State		[On]			
OS Reset Select		Cold Reset			
CSM Support		[Disabled]			
Boot Option Filter		[UEFI only]		→ ←: Select Screen ↑ ↓: Select Item Enter: Select +/-: Change Opt. F1: General Help F2: Previous Values F3: Optimized Defaults F4: Save & Reset ESC: Exit	
Boot Option Priorities					
Boot Option #1		[Windows Boot Manger]			
Version 2.21.1278 Copyright (C) 2022 AMI.					

The following table gives more information about important setup options within the Boot Menu. Default settings are displayed in **bold**.

Table 12: Boot Setup Menu Sub-screens and Functions

Function	Description
Full Screen LOGO Display	[Disabled, Enabled]
Setup Prompt Timeout	Displays number of seconds the firmware waits for setup activation key. Note: 65535 (0xFFFF) means an indefinite wait. [1]
Bootup NumLock State	Selects keyboard NumLock state [ON, OFF]
OS Reset Select	[Warm Reset, Cold Reset]
CSM Support	[Enabled, Disabled]
Boot Option Filter	[UEFI and Legacy, Legacy only, UEFI only]
Boot Option #1	Windows Boot Manager



UEFI only! No legacy support and no Master Boot Record (MBR) installation.

Function	Description		
Secure Boot Menu>	Factory Key Provision>	[Enabled , Disabled]	
		Restore Factory Keys	
		Reset To Setup Mode	
		Export Secure Boot variables	
		Enroll Efi Image	
	Device Guard Ready>	Remove 'UEFI CA' from DB	
		Restore DB defaults	
	Secure Boot Variable>	Platform Key (PK)	
		Key Exchange Keys	
		Authorized Signatures	
		Forbidden Signatures	
		Authorized TimeStamps	
		OsRecovery Signatures	

10.8. Save and Exit Setup Menu

Figure 23: Save and Exit Setup Menu Example

Aptio Setup - AMI					
Main	Advanced	Power	Boot	Security	Save & Exit
Save Changes and Reset				→ ←: Select Screen ↑ ↓: Select Item Enter: Select +/-: Change Opt. F1: General Help F2: Previous Values F3: Optimized Defaults F4: Save & Reset ESC: Exit	
Discard Changes and Reset					
Save Options					
Save Changes					
Discard Changes					
Restore Defaults					
Version 2.21.1278 Copyright (C) 2022 AMI.					

The following table gives more information about important setup options within the Save and Exit Menu.

Table 14: Save and Exit Setup Menu Sub-screens and Functions

Function	Description
Save Changes and Reset>	Exits system after saving changes Once you are finished making your selections, choose this option to ensure the values you selected are saved to the CMOS RAM. The CMOS RAM is sustained by an on-board backup lithium battery and stays on even when the PC is switched off. When you select this option, a confirmation window appears. Select [Yes] to save changes and exit.
Discard Changes and Reset>	Exits system setup without saving changes Select this option only if you do not want to save the changes that you made to the Setup program. If you made changes to fields other than system date, system time, and password, the BIOS will asks for a confirmation before exiting.
Save Options>	
Save Changes>	Saves changes made so far for any setup options
Discard Changes>	Discards changes made so far to any of the setup values This option allows you to discard the selections you made and restore the previously saved values. After selecting this option, a confirmation appears. Select [Yes] to discard any changes and load the previously saved values.
Restore Defaults>	Restores/loads standard default values for all setup options <u>Load Optimal Default values for all the setup values</u> This option allows you to load optimal default values for each of the parameters on the Setup menus, that provides the best performance settings The F9 key can be used for this operation.

11/Product Specification

11.1. Block Diagram

Figure 24: Block Diagram KBox A-151-TGL

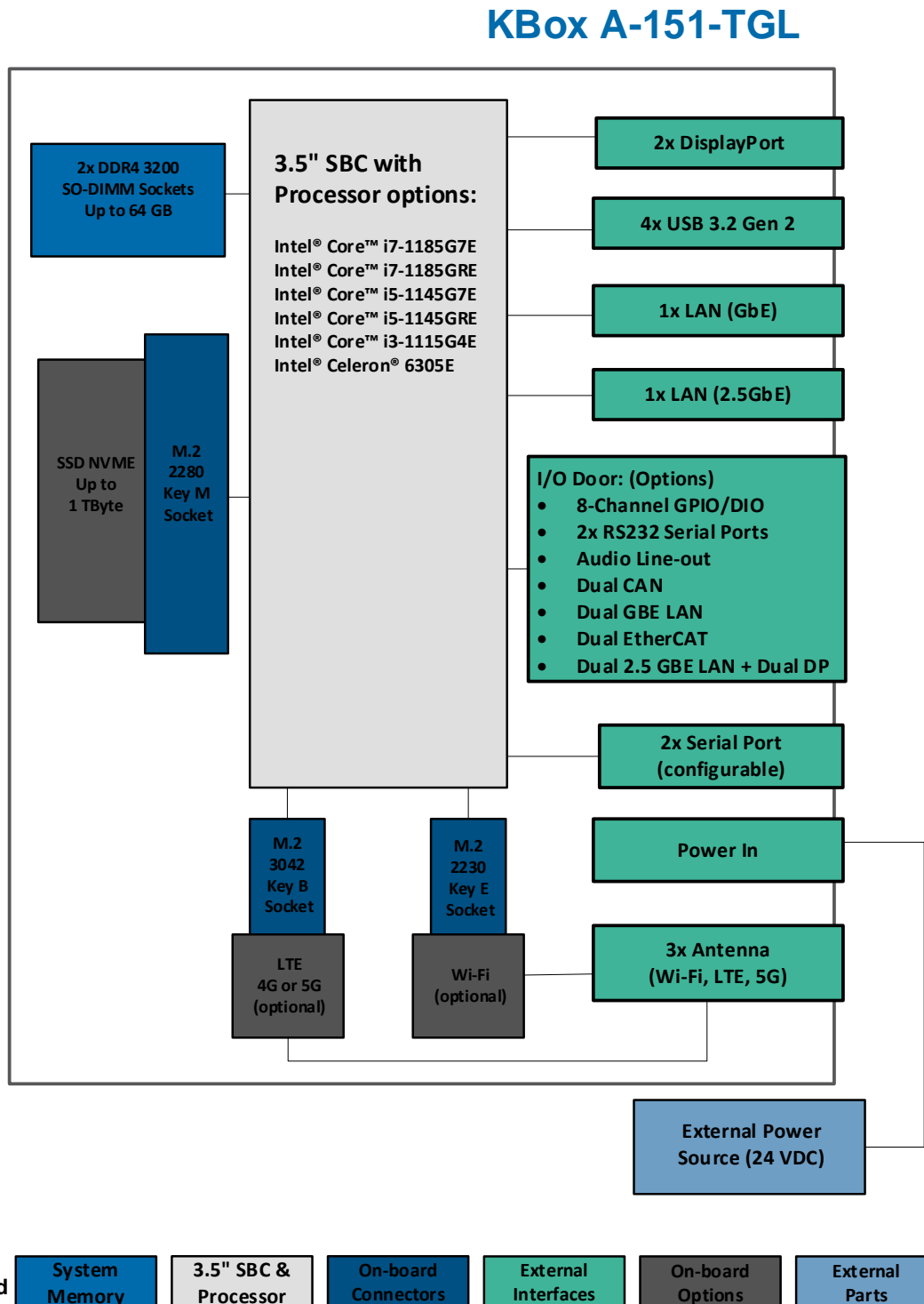

11.2. Hardware Specification

Table 15: Hardware Specification

Processor Board	3.5" SBC TGL			
Processor	Intel® Core™ i3-1115G4E	6 MB Cache	2.2 GHz/up to 3.9 GHz	15 W TDP
	Intel® Core™ i5-1145G7E and Intel® Core™ i5-1145GRE-XT ^[1]	8 MB Cache	1.5 GHz/up to 4.1 GHz	15 W TDP
	Intel® Core™ i7-1185G7E and Intel® Core™ i7-1185GRE-XT ^[1]	12 MB Cache	1.8 GHz/up to 4.4 GHz	15 W TDP
	Intel® Celeron® 6305E	4 MB Cache	1.8 GHz	15 W TDP
System Memory	SODIMM DDR4, 260-Pin Dual channel with one SODIMM per channel Up to 64 GB max. With 4 GB, 8GB, 16GB and 32 GB (with 64 GB on request)			
Internal Expansion Sockets	M.2 #1	M.2 Key M 2280 (PCIe x4) 256 GB, 512 Gb, 1 TB M.2 SSD module 3D TLC		
	M.2 #2	M.2 Key B 2242/3042/2280 (PCIe x1/SATA 3.0 & USB 2.0) with SIM card slot LTE 4G module or 5G module (with M.2 SSD on request) SIM card implemented with LTE 4G or 5G only		
	M.2 #3	M.2 Key E 2230 (PCIe x1, USB 2.0) Wi-Fi 2.4 GHz /Bluetooth V5 module		
External System Expansion I/O Door	8-Channel GPIO/DIO (option)			
	Audio Line-out (option)			
	Dual CAN (option)			
	Dual GBE LAN (option)			
	Dual RS232 Serial Ports (option)			
	Dual EtherCAT (option)			
RTC	3V lithium battery			
	Type: BR2032 with cable			
Power	24 VDC (Range: 10 VDC to 30 VDC) 6 A max. input current 60 W max. input power			
IP Protection Class	IP 20			

^[1] Extended temperature

11.3. Software Specification

Table 16: Software Specification

Operating System (OS)	Windows 10 IoT Enterprise BSP and Image Linux
BIOS	AMI Aptio V

11.4. Power Specification

Before connecting the product to an external DC power supply, ensure that the power supply meets the required electrical specification for the product, and that protection and supply limitation have been taken into consideration. The power supply used must automatically recover from AC power loss and start up under peak loading.

Connect the product only to a power supply designed to achieve NEC Class-2 and Limited Power Source (LPS).

Table 17: Electrical Specification

Input Voltage (nominal)	24 VDC
Input Voltage (range)	10 VDC to 30 VDC
Input Power (max.)	60 W
Input Current	6 A (max.)
Inrush Current	6 A

⚠ CAUTION

Only connect the product to an external power supply providing the voltage type (AC or DC) and the input power (max. current) specified on the Kontron Product Label and meeting the requirements of the Limited Power Source (LPS) and Power Source (PS2) of UL/IEC 62368-1.

⚠ CAUTION

Observe that wiring and short-circuit/overcurrent protection is performed according to the applicable standards, regulations and in respect to the product's electrical specification. The disconnecting device (fuse/circuit breaker) rating must be in accordance with the product's wire cross-section.

NOTICE

Ensure that the external DC power supply is used according to the manufacturer's instructions.

NOTICE

Ensure the external DC power supply has been fully tested to meet the minimum immunity of AC inputs requirements, as stipulated in IEC 55024. Including power supplies marketed with a separate AC/DC power converter.

NOTICE

Do not disconnect the power while the product is operating!
Performing a forced shut down can lead to loss of data or other undesirable effects!

NOTICE

To protect the product and any connected peripherals, make sure that the power cables have the right diameter to withstand the maximum available current.

11.4.1. Power Supply Protection Requirements

The external DC power supply is required to incorporate protection and supply features such as over current protection, inrush current protection, over voltage protection and under voltage (brownout) protection, to protect the product against fluctuations and interruptions in the delivered DC power supply.

NOTICE

If an under voltage (brownout) condition occurs the used power supply must remain in the "off state" long enough to allow internal voltages to discharge sufficiently. Failure to observe this "off state" may mean that parts of the product or peripherals work incorrectly or suffer a reduction of MTBF. The minimum "off state", to allow internal voltages to discharge sufficiently, is dependent on the power supply and additional electrical factors. To determine the required "off state", each case must be considered individually. For more information, contact Kontron Support.

11.4.2. Power Consumption

The external power supply used must be capable of delivering the product with the required power when configured with all components. The total power consumption depends on factors such as processor, LAN controller, memory and system expansion.

The total power requirement for the 24 Volt power supply depends on the product's application. For typical values, see Table 18: Power Consumption. The displayed values are all under normal load (50% Passmark).

Be aware that the DC power supply must be able to handle peak currents for several seconds.

Table 18: Power Consumption

Power Consumption	Intel® Core™ i3-1115G4E	Intel® Celeron® 6305E	Intel® Core™ i5-1145GRE	Intel® Core™ i7-1185GRE	Intel® Core™ i5-1145G7E	Intel® Core™ i7-1185G7E
Processor (TDP)	15 W	15 W	15 W	15 W	15 W	15 W
Mainboard Components	4 W	4 W	4 W	4 W	4 W	4 W
LAN (/port)	1.3W	1.3W	1.3W	1.3W	1.3W	1.3W
System Memory (8 GB DDR4)	1.5 W	1.5 W	1.5 W	1.5 W	1.5 W	1.5 W
Flash	4 W	4 W	4 W	4 W	4 W	4 W
M.2 Wi-Fi / 4G / 5G)	2.5/4/7W	2.5/4/7W	2.5/4/7W	2.5/4/7W	2.5/4/7W	2.5/4/7W

External connected devices such as USB and expansion devices have not been taken into account and must be considered separately. For the current and voltage provided per USB port, see Table 19: USB Current and Voltage provided per port.

Table 19: USB Current and Voltage provided per port

	USB 3.0
Current (Voltage) per Port (max.)	0.9 A (5 V)
Power per Port (max.)	4.5 W



The external DC power supply must supply the power required by all configured components.



The maximum ambient temperature depends mostly on the power consumption of the processor, chipset and third party components. For information regarding the maximum ambient temperature, see Chapter 6.6: Maximum Processor Temperatures.

11.4.3. Functional Earth

The functional earth bolt connects to the internal chassis ground. To avoid damage to the product, observe proper grounding methods.

1. Connect the product to ground before switching on the product.
2. Only connect the product to an applied ground that meets all applicable local, national and international grounding requirements.
3. When assembling, the first cable to be connected is the ground and when disassembling, the last cable to be removed is the ground cable.

▲ CAUTION

Ground Properly

The installation sites applied ground must meet your local, national and international region grounding requirements.

11.5. Environmental Specification

Table 20: Environmental Specification

	Description
Temperature (Operating)	Standard: 0°C to 60°C (32°F to 140°F) Standard with de-rating: 0°C to 65°C (32°F to 149°F) Extended: -40°C to 60° (-40°F to 140°F)
Temperature (Non-Operating)	-20°C to +85°C (-4°F to 185°F)
Humidity	According to IEC 60068-2-78 93% RH at 40°C, non-condensing
Shock (Operating)	According to IEC 60068-2-27 Peak Accel.: 15 g Shock Dur.: 11 ms half sine Shock Count: 3/direction., 18
Shock (Non-Operating)	According to IEC 60068-2-27 Peak Accel. 30 g Shock Dur. 11 ms half sine Shock Count: 3/direction, 18
Vibration	According to IEC 60068-2-6 Frequency: 10 Hz - 150 Hz Acceleration: 1 g
Altitude (Operating)	3000 m max. (9800 ft. max.)
Altitude (Non-Operating)	10000 m max. (32800 ft. max.)
Cooling Solution	Passive cooling solution via heatsink
MTBF	At 30°C Ground Benign (GB) 213 101.99 hours

11.6. Mechanical Specification

Table 21: Mechanical Specification

	Description
Material	Chassis: Steel Heatsink: Aluminium
Dimension (W x H x D)	180 mm x 70 mm x 123 mm (7.087" x 2.756" x 4.843")
Color	RAL7035 (front panel and main chassis) Black (heatsink)
Mounting	DIN Rail clamp (rear or bottom sides) Book mount bracket (rear or bottom sides)
Weight	1.6 kg approx. (3.53 lbs. approx.)
Protection Class	IP 20

Figure 25: Mechanical Dimensions (mm)

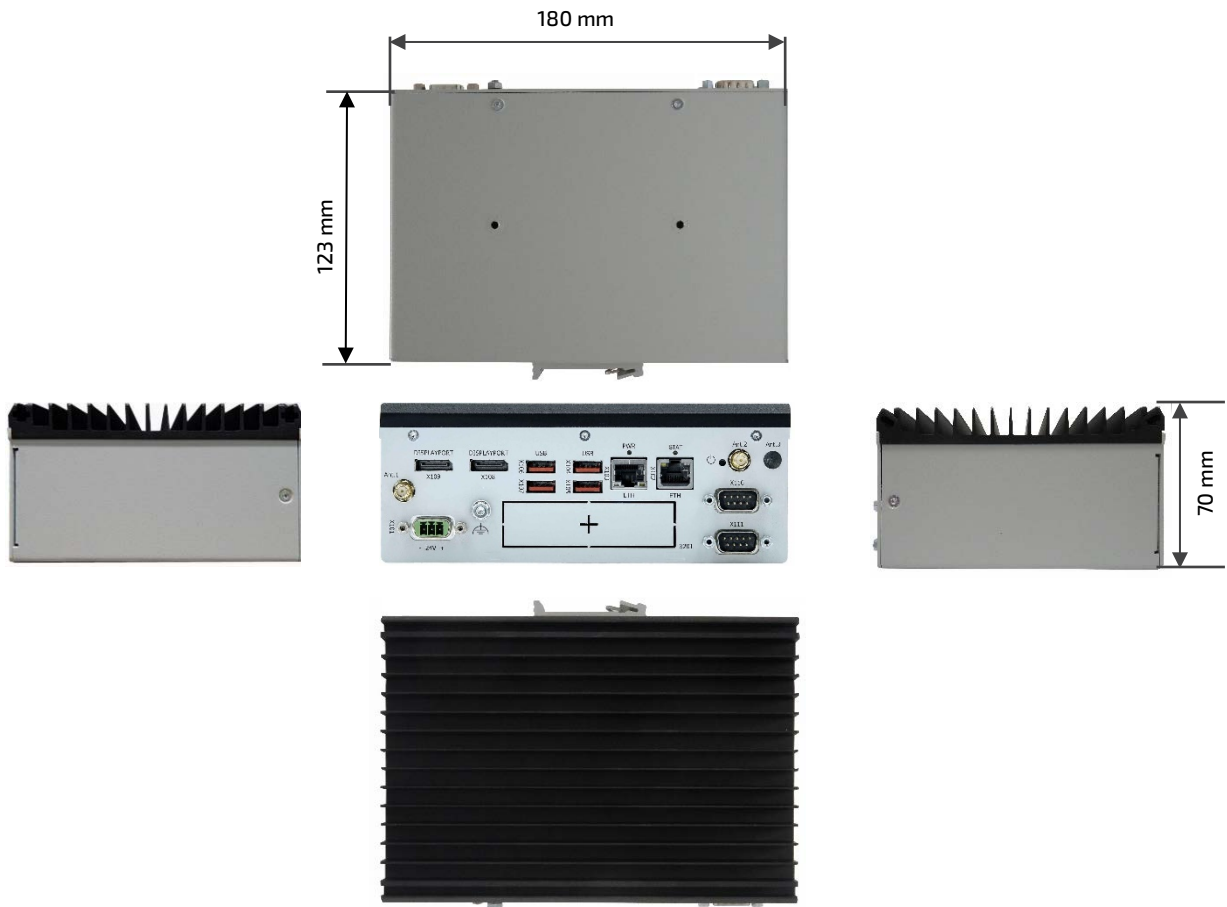

To access the KBox A 151-TGL STEP files, visit [Kontron's Customer Section](#).

11.7. Compliance

The KBox A-151-TGL plans to comply with the relevant requirements and the approximation of the laws relating to 'CE' (no Wi-Fi/LTE variant) and 'RED' (Wi-Fi/LTE variant), and the standards that are constitutional parts of the declaration.

Table 22: Compliance CE Mark

Europe – CE Mark	
Directives	2014/30/EU Electromagnetic compatibility 2014/35/EU Low Voltage 2011/65/EU RoHS II Restriction of the use of Hazardous Substances in electrical and electronic equipment
EMC	EN 55032 Electromagnetic compatibility of multimedia equipment- Emission Requirements EN 61000-6-2 Electromagnetic compatibility (EMC), part 6-2: Generic standards- Immunity for industrial environment
Safety	EN 61010-1 Safety requirements for electrical equipment for measurement, control and laboratory use - Part 1: General requirements

Table 23: Compliance RED mark

Europe – CE RED Mark	
Directives	2014/53/EU Radio Equipment Directive (RED) 2011/65/EU RoHS II
EMC	EN 55032 Electromagnetic compatibility of multimedia equipment- Emission Requirements EN 61000-6-2 Electromagnetic compatibility (EMC), Part 6-2: Generic standards- Immunity for industrial environment EN 301 489-1 V2.2.3 Electromagnetic Compatibility (EMC) standard for radio equipment and services; Part 1: Common technical requirements EN 301 489-17 V3.2.4 Electromagnetic Compatibility (EMC) standard for radio equipment and services; Part 17: Specific conditions for Broadband Data Transmission Systems EN 300 328 V2.2.2 Wideband transmission systems - Data transmission equipment operating in the 2,4 GHz band EN 301 893-2 V2.1.1 5 GHz RLAN
Safety	EN 61010-1 Safety requirements for electrical equipment for measurement, control and laboratory use - Part 1: General requirements
Health and Safety	EN 62311 Assessment of electronic and electrical equipment related to human exposure restrictions for electromagnetic fields (0 Hz - 300 GHz)

The KBox-A-151-TGL plans to comply with the following country specific certifications:

Table 24: International Compliance

USA/CANADA	
EMC	FCC 47 CFR Part 15 (Class B) and ICES-003 Complies with part 15 FCC rules and regulations of title 47 of the CFR rules for class B products; under which an unintentional radiator may be operated, administrated and other conditions relating to the marketing of part 15 devices.
Safety	UL 61010-1 and CSA-C22.2 No. 61010-1 Safety requirements for electrical equipment for measurement, control and laboratory use - Part 1: General requirements UL 61010-2-201 and CSA-C22.2 NO. 61010-2-201 Safety requirements for electrical equipment for measurement, control and laboratory use - Part 2-201: Particular requirements for control equipment
UK CA (UK Conformity Assessed)	
EMC	EN 55032 Electromagnetic compatibility of multimedia equipment- Emission Requirements EN 61000-6-2 Electromagnetic compatibility (EMC), Part 6-2: Generic standards- Immunity for industrial environment
Safety	EN 61010-1 Safety requirements for electrical equipment for measurement, control and laboratory use - Part 1: General requirements
International Certifications	
EMC	IEC 61000-6-2 Electromagnetic compatibility (EMC), Part 6-2: Generic standards- Immunity for industrial environment
Safety	IEC 61010-1 Safety requirements for electrical equipment for measurement, control and laboratory use - Part 1: General requirements



If the product is modified, the prerequisites for specific approvals may no longer apply.



For the product's Declaration of Conformity (DoC), visit [Kontron's Customer Section](#).



Kontron is not responsible for any radio television interference caused by unauthorized modifications of the delivered product or the substitution or attachment of connecting cables and equipment other than those specified by Kontron. The correction of interference caused by unauthorized modification, substitution or attachment is the user's responsibility.

12/ Connectors and LEDs

This chapter describes the KBox A-151-TGL's external connectors, status LEDs, sockets and relevant internal headers and jumpers.

For further motherboard information, visit <https://www.kontron.com/en/produkte/3.5--sbc-tgl/p160182>.

12.1. Front Panel Connector Pin Assignments

12.1.1. Power IN Connector (X101)

The Power IN connector connects to a 24 VDC DC power supply using the supplied mating power connector (PSC 1.5/ 3-F) and the corresponding wiring.

Table 25: Power IN Connector Pin Assignment

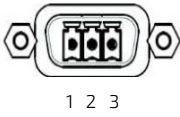
3-Pin Phoenix PSC 1.5/3-M	Pin	Signal Name / Description
	1	GND (-)
	2	Connected to system chassis (electrical connected to functional earth bolt)
	3	VCC (+)

12.1.2. LAN Connectors (X102, X103)

The two Ethernet port connectors support one channel of 10/100/1000/2500 Mbit Ethernet (X102) and one channel of 10/100/1000 Mbit Ethernet (X103). Each Ethernet port has two LEDs indicating speed and activity.

The orientation of the Ethernet connector LAN Status LEDs (Speed and Activity) differ, with 2.5 GbE LAN at the top of the RJ45 connector and GbE at the bottom of the RJ45 connector.

Table 26: 2.5 GbE LAN Connector Pin Assignment (X102)

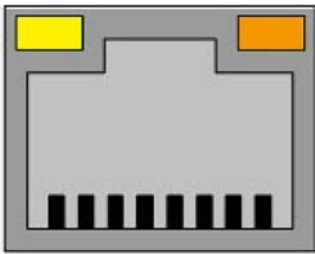
RJ45 (female) X102	Pin	Signal Name
	1	TX1+
	2	TX1-
	3	TX 2+
	4	TX 3+
	5	TX 3-
	6	TX 2-
	7	TX 4+
	8	TX 4-

Left LED: Link Activity		Right LED: Speed	
Off	Link down	Off	10/100 Mbit/s
Yellow Flashing	Link up and active	Orange	1000 Mbit/s
Yellow	Link up and no activity	Green	2.5 Gbit/s

Signal	Description
TX1+ / TX1-	In MDI mode, this is the first pair in 2.5GBase-T and 1000Base-T, i.e. the BL_DA+/- pair, and is the transmit pair in 10Base-T and 100Base-TX. In MDI crossover mode, this pair acts as the BL_DB+/- pair, and is the receive pair in 10Base-T and 100Base-TX.

Signal	Description
TX2+ / TX2-	In MDI mode, this is the second pair in 2.5GBase-T and 1000Base-T, i.e. the BI_DB+/- pair, and is the receive pair in 10Base-T and 100Base-TX. In MDI crossover mode, this pair acts as the BI_DA+/- pair, and is the transmit pair in 10Base-T and 100Base-TX.
TX3+ / TX3-	In MDI mode, this is the third pair in 2.5GBase-T and 1000Base-T, i.e. the BI_DC+/- pair. In MDI crossover mode, this pair acts as the BI_DD+/- pair.
TX4+ / TX4-	In MDI mode, this is the fourth pair in 2.5GBase-T and 1000Base-T, i.e. the BI_DD+/- pair. In MDI crossover mode, this pair acts as the BI_DC+/- pair.



To achieve the specified performance of the Ethernet port, Category 5 twisted pair cables must be used with 10/100 MByte and Category 5E, 6 or 6E with 1 Gbit/2.5Gbit LAN networks.



The product is to be connected only to internal Ethernet networks without exiting a facility and being subjected to TNVs.

Table 27: 1.0 GbE LAN Connector Pin Assignment (X103)

RJ45 (female) X103	Pin	Signal Name
	1	TX1+
	2	TX1-
	3	TX 2+
	4	TX 3+
	5	TX 3-
	6	TX 2-
	7	TX 4+
	8	TX 4-

Left LED: Speed		Right LED: Link Activity	
Off	10 Mbit/s	Off	Link down
Green	100 Mbit/s	Yellow Flashing	Link up and active
Orange	1000 Mbit/s	Yellow	Link up and no activity

Signal	Description
TX1+ / TX1-	In MDI mode, this is the first pair in 1000Base-T, i.e. the BI_DA+/- pair, and is the transmit pair in 10Base-T and 100Base-TX. In MDI crossover mode, this pair acts as the BI_DB+/- pair, and is the receive pair in 10Base-T and 100Base-TX.
TX2+ / TX2-	In MDI mode, this is the second pair in 1000Base-T, i.e. the BI_DB+/- pair, and is the receive pair in 10Base-T and 100Base-TX. In MDI crossover mode, this pair acts as the BI_DA+/- pair, and is the transmit pair in 10Base-T and 100Base-TX.
TX3+ / TX3-	In MDI mode, this is the third pair in 1000Base-T, i.e. the BI_DC+/- pair. In MDI crossover mode, this pair acts as the BI_DD+/- pair.
TX4+ / TX4-	In MDI mode, this is the fourth pair in 1000Base-T, i.e. the BI_DD+/- pair. In MDI crossover mode, this pair acts as the BI_DC+/- pair.



To achieve the specified performance of the Ethernet port, Category 5 twisted pair cables must be used with 10/100 MByte and Category 5E, 6 or 6E with 1 Gbit/2.5Gbit LAN networks.



The product is to be connected only to internal Ethernet networks without exiting a facility and being subjected to TNVs.

12.1.3. USB 3.2 Gen 2 Port Connectors (X107, X106, X105, X104)

The four USB ports connectors (X107, X106, X105 and X104) support USB 3.2 Gen 2 compatible devices.



USB 3.2 Gen 2 ports are backwards compatible with USB 2.0

Table 28: USB Type A Pin Assignment (USB)

USB Type A	Pin	Signal Name	Description
	1	+USB_VCC	+5 V power supply for USB device
	2	USB_D-	USB 2.0 differential pair (-)
	3	USB_D+	USB 2.0 differential pair (+)
	4	GND	Ground
	5	USB_RX-	USB 3.2 receiver differential pair (-)
	6	USB_RX+	USB 3.2 receiver differential pair (+)
	7	GND	Ground
	8	USB_TX-	USB 3.2 transmitter differential pair (-)
	9	USB_TX+	USB 3.2 transmitter differential pair (+)



USB power source can be selected by the USB Power Selection Jumper.

12.1.4. Display Port Connectors (X109, X108)

The two Display Port (DP) connectors (X109, X108) are standard DP ports.

Table 29: Display Port Connector Pin Assignment

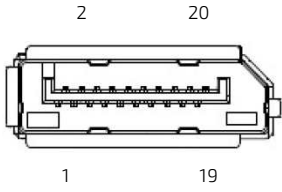
20-pin Standard DP Connector (female)	Pin	Signal Name	Pin	Signal Name
	1	TX0+	11	GND
	2	GND	12	TX3-
	3	TX0-	13	Config1
	4	TX1+	14	Config2
	5	GND	15	AUX+
	6	TX1-	16	GND
	7	TX2+	17	AUX-
	8	GND	18	HPD
	9	TX2-	19	GND
	10	TX3+	20	PWR

Signal Name	Description
TX# +/-	DisplayPort Lane # transmitter differential pair (+/-)
Aux +/-	DisplayPort Auxiliary channel differential pair (+)
HPD	Display Port hot plug detect
Config#	Connect to Ground directly or via a pulldown device
GND	Ground signal
PWR	Power supply signal for connector

12.1.5. Serial Port Connectors (X111, X110)

The two serial ports (X111 and X110) support RS232/422/485 configurations.

Table 30: Serial Port Pin Assignment (x110, X111)

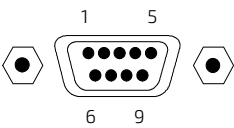
9-pin D-SUB (male)	Pin	RS232	RS422	RS485 (Half Duplex)	RS485 (Full Duplex)
	1	DCD	Tx-	Data-	Tx-
	2	RxD	Tx+	Data+	Tx+
	3	TxD	Rx+		RX+
	4	DTR	Rx-		Rx-
	5	GND	GND	GND	GND
	6	DSR			
	7	RTS			
	8	CTS			
	9	RI			

Signal Name	Description
DCD	Data Carrier Detect

Signal Name	Description
TXD	Transmitted Data sends data to the communications link. The signal is set to the marking state (-12 V) on hardware reset when the transmitter is empty or when loop mode operation is initiated.
RXD	Received Data, receives data from the communications link.
DTR	Data Terminal Ready indicates that the on-board UART is ready to establish communication link.
DSR	Data Set Ready, indicates that the modem etc. is ready to establish a communications link.
RTS	Request To Send, indicates to the modem etc. that the on-board UART is ready to
RI	Ring Indicator, indicates that the modem has received a ringing signal from the telephone line.
TX+/-	Transmitted Data differential pair sends data to the communications link.
RX+/-	Received Data differential pair receives data from the communications link.
GND	Power supply GND signal

12.1.6. Power Button

The power button switches on and switches off the product.

12.1.7. Power LED and STAT LED

The PWR and STAT LEDs indicate the product's power and state. For a description of the LED activity, see Chapter 4.1.4: Power LED and State LED.

12.1.8. Antenna (Ant.1, Ant.2, Ant.3)

The Wi-Fi, LTE (4G) and 5G the antenna connectors are RP-SMA female connectors requiring a RP-SMA male antenna.

Additional antennas may be implemented on the system expansion I/O door if the I/O door is not implemented with another feature.

Figure 26: RP-SMA Standard Connector (female) and Antenna (male)



RP-SMA (female)



RP-SMA (male)



Use a RP-SMA Antenna only. SMA Antenna connections are not electrically compatible.

12.2. System Expansion I/O Door Pin Assignments (X201)



It is only possible to implement one of the system expansion options in the I/O door.

12.2.1. Audio Line-out Connector (option)

The audio line-out option is factory installed for use with a 3.5 mm stereo audio jack to enable the connection of external active speakers and headphones, or other output devices.

Table 31: Audio Lin-out Connector Pin Assignment

Audio-Lineout	Pin	Signal Name	Description
	1	AUD-LO-L	Line-out left
	2	AUO-LO-R	Line-out right
	3	GND	Ground

12.2.2. Dual CAN Bus Connectors (option)

The dual CAN bus expansion option supports two CAN bus 2.0B ports that are backwards compatible with CAN bus 2.0A and meeting the requirements of ISO 11898-1.



Prerequisite: Motherboards M.2 2280 B socket is not populated with a different M.2 module.

Table 32: Dual CAN Ports Pin Assignment

D89 Port	Pin	Signal Name	Description
	1	NC	
	2	CAN-L	
	3	GND	
	4	NC	
	5	NC	
	6	NC	
	7	CAN-H	
	8	NC	
	9	NC	

12.2.3. Dual EtherCAT Connectors (option)

The EtherCAT expansion option supports two EtherCat ports with Auto Crossover and switching between RX and TX.

NOTICE

The EtherCAT RJ45 connectors may only be used for LAN. Use for telecommunications is not possible.



Prerequisite: Motherboards M.2 2280 B socket is not populated with a different M.2 module.

Table 33: EtherCAT Port Pin Assignment

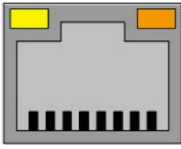
RJ45 Port (female)	Pin	Signal Name	Description
 <p>8 7 6 5 4 3 2 1</p>	1	TX+	
	2	TX-	
	3	RX +	
	4	Term _1	
	5	Term_1	
	6	RX -	
	7	Term_2	
	8	Term_2	

12.2.4. Dual LAN Connectors (option)

The dual LAN expansion option supports two GbE LAN ports.



Prerequisite: Motherboards M.2 2280 B socket is not populated with a different M.2 module.

Table 34: Dual (GbE) LAN Ports Pin Assignment

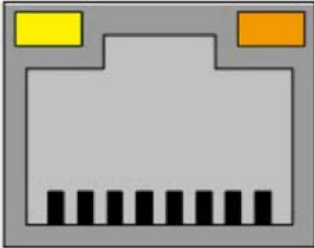
RJ45 (female)	Pin	Signal Name
 <p>8 7 6 5 4 3 2 1</p>	1	TX1+
	2	TX1-
	3	TX 2+
	4	TX 3+
	5	TX 3-
	6	TX 2-
	7	TX 4+
	8	TX 4-

12.2.5. Dual RS232 Serial Port Connectors (option)

The dual RS232 expansion option supports two RS232 serial outputs.

Table 35: Dual RS232 Pin Assignment

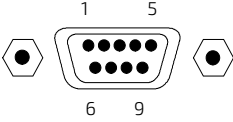
9-pin D-SUB (male)	Pin	RS232	Description
	1	DCD	Data Carrier Detect
	2	RxD	Received Data, receives data from the communications link.
	3	TxD	Transmitted Data, sends data to the communications link.
	4	DTR	Data Terminal Ready, indicates that the UART is ready to establish a communication link.
	5	GND	GND signal
	6	DSR	Data Set Ready, indicates that the modem etc. is ready to establish a communications link.
	7	RTS	Request To Send, indicates to the modem etc. that the on-board UART is ready to
	8	CTS	Clear To Send authorisation signal that data can be received.
	9	RI	Ring Indicator, indicates that the modem has received a ringing signal from the telephone line.

12.2.6. 8-Channel GPIO/DIO Connector (option)

The GPIO expansion option supports eight GPIO bi-directional digital IO signals.

Table 36: GPIO/DIO Connector Pin Assignment

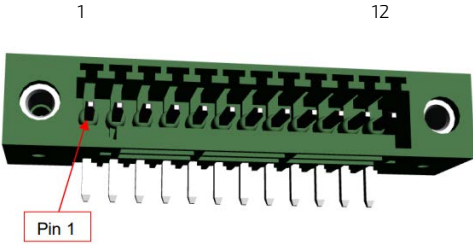
12-pin GPIO Connector	Pin	Signal Name	Direction	Description
	1	PWR_IN	Power	Power Input 10 V to 30 V (Power Inputs fused with 3A)
	2	PWR_IN	Power	
	3	NC		
	4	GPIO1	In/Out	GP Input /Output Channel
	5	GPIO2	In/Out	
	6	GPIO3	In/Out	
	7	GPIO4	In/Out	
	8	GPIO5	In/Out	
	9	GPIO6	In/Out	
	10	GPIO7	In/Out	
	11	GPIO8	In/Out	
	12	GND	Ground	Ground



Mating Connector Information:

- 691381030012 WR-TBL Serie 381 or equivalent from Würth Elektronik
- 12-pin 2.50 mm vertical CAB entry plug screw less with Flanges
- Stranded Wire: 24-16 AWG / 0.205-1.31 MM²

12.2.7. Dual LAN and Dual DP Connectors (option)

The dual LAN and dual DP expansion option supports two 2.5 GBE RJ45 LAN ports with speed and activity indication LEDs and two DP ports.

Table 37: Dual LAN and Dual DP Module Pin Assignments

LAN RJ45				DP			
Pin	Signal Name			Pin	Signal Name	Pin	Signal Name
1	TX1+			1	TX0+	11	GND
2	TX1-			2	GND	12	TX3-
3	TX 2+			3	TX0-	13	Config1
4	TX 3+			4	TX1+	14	Config2
5	TX 3-			5	GND	15	AUX+
6	TX 2-			6	TX1-	16	GND
7	TX 4+			7	TX2+	17	AUX-
8	TX 4-			8	GND	18	HPD
Left LED: Speed		Right LED: Activity		9	TX2-	19	GND
Off	10/100 Mbit/s	Off	Link down	10	TX3+	20	PWR
Orange	1000 Mbit/s	Yellow Flashing	Link up & active				
Green	2.5 Gbit/s	Yellow	Link up & no activity				

Signal	Description
TX1+ / TX1-	In MDI mode, this is the first pair in 2.5GBase-T and 1000Base-T, i.e. the BI_DA+/- pair, and is the transmit pair in 10Base-T and 100Base-TX. In MDI crossover mode, this pair acts as the BI_DB+/- pair, and is the receive pair in 10Base-T and 100Base-TX.
TX2+ / TX2-	In MDI mode, this is the second pair in 2.5GBase-T and 1000Base-T, i.e. the BI_DB+/- pair, and is the receive pair in 10Base-T and 100Base-TX. In MDI crossover mode, this pair acts as the BI_DA+/- pair, and is the transmit pair in 10Base-T and 100Base-TX.
TX3+ / TX3-	In MDI mode, this is the third pair in 2.5GBase-T and 1000Base-T, i.e. the BI_DC+/- pair. In MDI crossover mode, this pair acts as the BI_DD+/- pair.
TX4+ / TX4-	In MDI mode, this is the fourth pair in 2.5GBase-T and 1000Base-T, i.e. the BI_DD+/- pair. In MDI crossover mode, this pair acts as the BI_DC+/- pair.
Signal Name	Description
TX# +/-	DisplayPort Lane # transmitter differential pair (+/-)
Aux +/-	DisplayPort Auxiliary channel differential pair (+)
HPD	Display Port hot plug detect
Config#	Connect to Ground directly or via a pulldown device
GND	Ground signal
PWR	Power supply signal for connector

12.3. Socket Pin Assignments

12.3.1. M.2 Key E 2230 Socket

The M.2 Key E 2230 module socket supports PCIe x1, USB 2.0, UART, PCM and / or CNVi signals. The socket implements a Wi-Fi or CNVi Wi-Fi/Bluetooth module.



The module type (Key E/CNVi) is auto-detected and re-configured to the appropriate mode.

Figure 27: M.2 Key E 2230 Socket

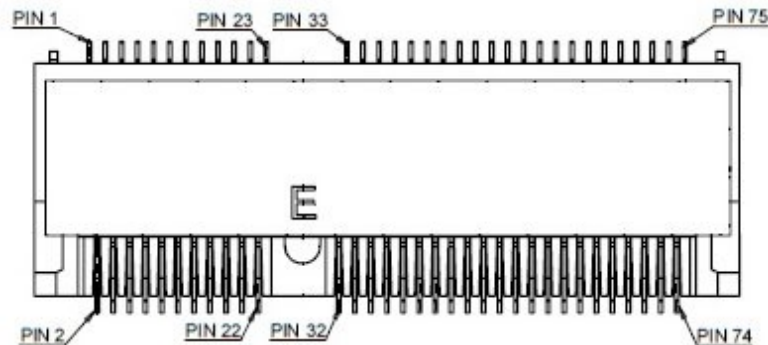

Table 38: M.2 Key E 2230 Socket Pin Assignment

Pin	Key E*		CNVi*	
	Signal	Description	Signal	Description
1	GND	Ground	GND	Ground
2	+3.3V	3.3 V power supply	+3.3V	3.3 V power supply
3	USB_D+	USB 2.0 data diff. pair (+)	-	
4	+3.3V	3.3 V power supply	+3.3V	3.3 V power supply
5	USB_D-	USB 2.0 data diff. pair (-)	-	
6	LED1#	Device active signal 1	LED1#	Device active signal 1
7	GND	Ground	GND	Ground
8	PCM_CLK	PCM synchronous data clock	-	
9	-		WGR_D1N	CNVio bus Rx Lane 1 (-)
10	PCM_SYNC	PCM synchronous data sync	LCP_RSTN	RF companion (CRF) reset
11	-		WGR_D1P	CNVio bus Rx Lane 1 (+)
12	PCM_IN	PCM synchronous data input	-	
13	GND	Ground	GND	Ground
14	PCM_OUT	PCM synchronous data output	CLKREQ0	Clock request
15	-		WGR_D0N	CNVio bus Rx Lane 0 (-)
16	LED2#	Device active signal 2	LED2#	Device active signal 2
17	-		WGR_D0P	CNVio bus Rx Lane 0 (+)
18	GND	Ground	GND	Ground

Pin	Key E*		CNVi*	
	Signal	Description	Signal	Description
19	GND	Ground	GND	Ground
20	UART_WAKE#	UART wake-up	-	
21	-		WGR_CLKN	CNVio bus Rx clock (-)
22	UART_RX	UART data input	BRI_RSP	BRI bus Rx
23	-		WGR_CLKP	CNVio bus Rx clock (+)
24	Key		Key	
25	Key		Key	
26	Key		Key	
27	Key		Key	
28	Key		Key	
29	Key		Key	
30	Key		Key	
31	Key		Key	
32	UART_TX	UART data output	RGI_DT	RGI bus Tx
33	GND	Ground	GND	Ground
34	UART_CTS	UART clear to send	RGI_RSP	RGI bus Rx
35	PET0+	PCIe Lane 0 Tx pair (+)	-	
36	UART_RTS	UART request to send	BRI_DT	BRI bus Tx
37	PET0-	PCIe Lane 0 Tx pair (-)	-	
38	Clink_RST	Wi-Fi CLINK host bus reset	-	
39	GND	Ground	GND	Ground
40	Clink_DATA	Wi-Fi CLINK host bus data	-	
41	PER0+	PCIe Lane 0 Rx pair (+)	-	
42	Clink_CLK	Wi-Fi CLINK host bus clock	-	
43	PER0-	PCIe Lane 0 Rx pair (-)	-	
44	-		-	
45	GND	Ground	GND	Ground
46	-		-	
47	REFCLK0+	PCIe reference clock pair (+)	-	
48	-		-	
49	REFCLK0-	PCIe reference clock pair (-)	-	
50	SUSCLK	32.768 kHz clock supply input	SUSCLK	32.768 kHz clock supply input
51	GND	Ground	GND	Ground
52	PERST0#	PCIe reset	-	
53	CLKREQ0#	Reference clock request signal	-	
54	W_DISABLE2#	Wireless disable 2	W_DISABLE2#	Wireless disable 2
55	PEWAKE0#	PCIe wake	-	
56	W_DISABLE1#	Wireless disable 1	W_DISABLE1#	Wireless disable 1
57	GND	Ground	GND	Ground
58	-		-	
59	-		WT_D1N	CNVio bus Tx Lane 1 (-)

Pin	Key E*		CNVi*	
	Signal	Description	Signal	Description
60	-		-	
61	-		WT_D1P	CNVio bus Tx Lane 1 (+)
62	-		-	
63	GND	Ground	GND	Ground
64	-		REFCLK0	Reference clock
65	-		WT_D0N	CNVio bus Tx Lane 0 (-)
66	-		-	
67	-		WT_D0P	CNVio bus Tx Lane 0 (+)
68	-		-	
69	GND	Ground	GND	Ground
70	-		-	
71	-		WT_CLKN	CNVio bus Tx clock (-)
72	+3.3V	3.3 V power supply	+3.3V	3.3 V power supply
73	-		WT_CLKP	CNVio bus Tx clock (+)
74	+3.3V	3.3 V power supply	+3.3V	3.3 V power supply
75	GND	Ground	GND	Ground

12.3.2. M2. Key B 2242/3042/2280 Socket

The M.2 key B 2242/3042/2280 socket supports PCIe x1 / SATA 3.0 and USB 2.0 signals as well as UIM signals connected to the micro SIM card holder. The socket implements a cellular LTE module.

Table 39: M.2 Key B 2242/3042/2280 Socket Pin Assignment

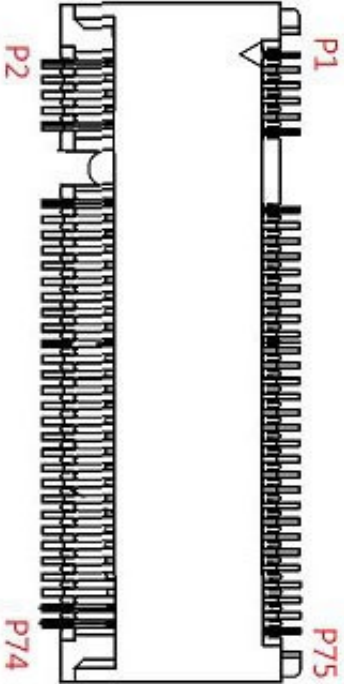
M.2 Key B socket	Pin	Signal Name	Pin	Signal Name
	1	-	2	3.3V
	3	GND	4	3.3V
	5	GND	6	PWROFF#
	7	USB_D+	8	DISABLE1
	9	USB_D-	10	LED_1#
	11	GND	12	Key
	13	Key	14	Key
	15	Key	16	Key
	17	Key	18	Key
	19	Key	20	-
	21	-	22	-
	23	-	24	-
	25	-	26	-
	27	GND	28	-
	29	-	30	UIM RESET ^[1]
	31	-	32	UIM CLK ^[1]
	33	GND	34	UIM DATA ^[1]
	35	-	36	UIM PWR ^[1]
	37	-	38	-
	39	GND	40	-
	41	PERn0 / SATA_B+	42	-
	43	PERp0 / SATA_B-	44	-
	45	GND	46	-
	47	PETn0 / SATA_A-	48	-
	49	PETp0 / SATA_A+	50	PERST#
	51	GND	52	CLKREQ#
	53	PCIe REFCLK-	54	PCIe WAKE#
	55	PCIe REFCLK+	56	-
	57	GND	58	-
	59	-	60	-
	61	-	62	-
	63	-	64	-
	65	-	66	SIM Detect
	67	-	68	SUSCLK
	69	-	70	3.3V
71	GND	72	3.3V	
73	GND	74	3.3V	
75	NC			

^[1] These pins are connected to the Micro SIM card holder directly.

12.3.3. M.2 Key M 2280 Slot Socket

The M.2 key M 2280 socket supports PCIe x4 signals. The socket implements a SSD (NVMe) module.

Table 40. M.2 Key M 2280 Socket Pin Assignment

M.2 Key M socket	Pin	Signal Name	Pin	Signal Name
	1	GND	2	3.3V
	3	GND	4	3.3V
	5	PERn3	6	NC
	7	PERp3	8	NC
	9	GND	10	DAS/DSS# /LED1#
	11	PETn3	12	3.3V
	13	PETp3	14	3.3V
	15	GND	16	3.3V
	17	PERn2	18	3.3V
	19	PERp2	20	NC
	21	GND	22	NC
	23	PETn2	24	NC
	25	PETp2	26	NC
	27	GND	28	NC
	29	PERn1	30	NC
	31	PERp1	32	NC
	33	GND	34	NC
	35	PETn1	36	NC
	37	PETp1	38	DEVSLP
	39	GND	40	NA
	41	PERn0	42	NA
	43	PERp0	44	NA
	45	GND	46	NC
	47	PETn0	48	NC
	49	PETp0	50	PERST#
	51	GND	52	CLKREQ#
	53	REFCLKn	54	PEWAKE#
	55	REFCLKp	56	NC
57	GND	58	NC	
59	Key	60	Key	
61	Key	62	Key	
63	Key	64	Key	
65	Key	66	Key	
67	NC	68	SUSCLK	
69	PEDET	70	3.3V	
71	GND	72	3.3V	
73	GND	74	3.3V	
75	GND			

12.3.4. Micro SIM Card Holder

The micro SIM card holder or M.2 Key B accommodates a micro SIM card and connects to UIM signals on the M.2 Key B slot.



SIM card required by LTG 4G or 5 G implementation only.

Table 41: SIM Card Holder Pin Assignment

Micro SIM Card Holder	Pin	Signal	Description
	C1	VCC	Power +3.3 V
	C2	RST	Reset signal
	C3	CLK	Clock signal
	C4	NC	Not connected
	C5	GND	Ground
	C6	VPP	Programming voltage input
	C7	IO	Input or Output for serial data
	C8	NC	Not connected

12.4. Header and Jumper Pin Assignments

This chapter provides the pin assignment of relevant on-board headers and jumpers.

12.4.1. RTC Lithium Battery Power Input Header

The on-board RTC Lithium battery power input header connects to the lithium battery. The lithium battery provides power to the system clock to retain the time when power is switch off.

Table 42: RTC Lithium Battery Connector Pin Assignment

2-pin, 1.25 mm Pitch	Pin	Signal Name	Description
	1	+VRTC	Real-time clock backup lithium battery input
	2	GND	Ground

12.4.2. Clear CMOS Selection Jumper

The Clear COMS Selection jumper resets the Real Time Clock (RTC) and drains the RTC well. The jumper has one position: Pin 1-2 mounted (default position) and Pin 2-3 mounted.

Table 43: Clear CMOS Selection Jumper Pin Assignment

3-pin 2.0 mm Pitch	Jumper Position		Description
	Pin 1-2	Pin 2-3	
	X	-	Normal Operation (default position)
	-	X	Clear CMOS (product does not boot with the jumper in this position)

"X" = Jumper set (short) and "-" = jumper not set (open)



Do not leave the jumper in position 2-3, otherwise if the power is disconnected, the lithium battery will fully deplete within a few weeks.

12.4.3. M.2 Key B Selection Jumper

The M.2 Key B Selection" jumper selects the M.2 SSD the M.2 Key B slot interface.

Table 44: M.2 Key B Selection Jumper

3-pin 2.0 mm Pitch	Jumper Position		Description
	Pin 1-2	Pin 2-3	
	X	-	PCIe x1
	-	X	SATA (Default)

"X" = Jumper set (short) and "-" = jumper not set (open)

13/ Maintenance

Maintenance or repair on the product may only be carried out by trained personnel authorized by Kontron. Kontron products require only minimum servicing and maintenance for problem-free operation.

⚠ CAUTION

Handling and operation of the product is permitted only for trained personnel aware of the associated dangers, within a work place that is access controlled and fulfills all necessary technical and environmental requirements.

NOTICE

Protection label

The product is factory configured to meet customer requirements and then sealed with a protection label. Opening the product invalidates the warranty and may cause damage to internal components.

NOTICE

Internal Components are not accessible in the field. For replacement or installation, the product must be returned to Kontron, see Chapter 15.1: Returning Defective Merchandise.

13.1. Cleaning



Hot Surface

The heatsink can get very hot. To avoid burns and personal injury when handling the heatsink:

- Do not touch while in operation
- Allow to cool before handling
- Wear protective gloves

Surface chaude

Le dissipateur thermique peut devenir très chaud. Pour éviter les brûlures et les blessures lors de la manipulation du dissipateur thermique :

- Ne pas toucher pendant le fonctionnement
- Laisser refroidir avant la manipulation
- Portez des gants de protection

To clean the surface of the product, perform the following:

1. Close all applications. Shut down properly using the power button and disconnect the power cable from the Power IN connector or the DC power supply. Disconnect all peripherals.
2. Allow the product to cool before handling and do not touch the heatsink when the product is in operation.
3. Carefully remove dust using a clean soft brush and if light soiling clean the product with a dry cloth.
4. Remove stubborn dirt using a mild detergent and a soft cloth.

13.2. Replacing the Lithium Battery

The internal lithium battery BR2032 with cable must be replaced with an identical three Volt lithium battery or a Kontron recommended lithium battery, see Table 2: Accessories.

NOTICE

Internal Components are not accessible in the field. For replacement or installation, the product must be returned to Kontron, see Chapter 15.1: Returning Defective Merchandise.

CAUTION

CAUTION: Risk of Explosion if the lithium battery is replaced by an incorrect type. Dispose of used lithium batteries according to the Instructions.

ATTENTION: Risque d'explosion si la pile au lithium est remplacée par une pile de type incorrect. Éliminez les piles au lithium usagées conformément aux instructions.



Do not dispose of lithium batteries in general trash collection. Dispose of the lithium battery according to the local regulations dealing with the disposal of these special materials, (e.g. to the collecting points for dispose of batteries).



The product is not designed to operate without a lithium battery. If the lithium battery is empty or disconnected, the BIOS settings will be set to the factory defaults.

Figure 28: Lithium Battery

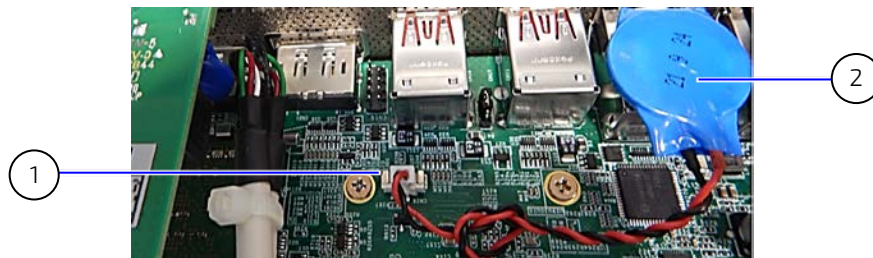

1 3.5" SBC RTC header

2 Lithium battery BR2032 with cable (fixed)

The internal lithium battery BR2032 with cable must be replaced with an identical three Volt lithium battery or a Kontron recommended lithium battery. To replace the lithium battery, perform the following:

1. Open the product as described in Chapter 7.2: Opening the Product, steps 3 to 7.
2. Locate and disconnect the lithium battery cable from the RTC power input header and remove the lithium battery from the top of the housing of the X103 LAN connector.
3. Replace a new lithium battery of the same type by inserting the new lithium battery's cable connector into the RTC power input header.
4. Secure the lithium battery to the top of the housing of the X103 LAN connector.
5. Close the product as described in Chapter 7.2: Opening the Product, step 8.

14/ Storage and Transportation

14.1. Storage

If the product is not in use for an extended period of time, disconnect the product from the main power supply. If it is necessary to store the product, then repack the product as originally delivered to avoid damage. The storage facility must meet the product's environmental storage requirements as stated within this user guide. Kontron recommends keeping the original packaging material for future storage or warranty shipments.

14.2. Transportation

To ship the product, use the original packaging, designed to withstand impact and adequately protect the product. When packing or unpacking the product always take shock and ESD protection into consideration and use an EOS/ESD safe working area.

15/ Technical Support

Should a problem occur that cannot be solved using the trouble shooting information above, contact Kontron's Support Department:

- ▶ Email: support@kontron.com
- ▶ Phone: +49-821-4086-888

Make sure you have the following information available when you call:

- ▶ Product ID Number (PN)
- ▶ Serial Number (SN)



The serial number can be found on the product's type label.

Be ready to explain the nature of your problem to the service technician.

15.1. Returning Defective Merchandise

All equipment returned to Kontron must have a Return of Material Authorization (RMA) number assigned exclusively by Kontron. Kontron cannot be held responsible for any loss or damage caused to the equipment received without an RMA number. The buyer accepts responsibility for all freight charges for the return of goods to Kontron's designated facility. Kontron will pay the return freight charges back to the buyer's location in the event that the equipment is repaired or replaced within the stipulated warranty period.

Follow these steps before returning any product to Kontron.

1. Visit the RMA Information website: <http://www.kontron.com/en/support/rma-information>
2. Download the RMA Request sheet for **Kontron Europe GmbH – Augsburg** and fill out the form. Take care to include a short detailed description of the observed problem or failure and to include the product identification information (Name of product, Product number and Serial number). If a delivery includes more than one product, fill out the above information in the RMA Request form for each product.
Send the completed RMA-Request form to the fax or email address given on the RMA Request sheet and Kontron will provide an RMA-Number.
3. The goods for repair must be packed properly for shipping, considering shock and ESD protection.



Goods returned to Kontron in non-proper packaging will be considered as customer caused faults and cannot be accepted as warranty repairs.

4. Include the RMA-Number with the shipping paperwork and send the product to the delivery address provided in the RMA form or received from Kontron RMA Support.

15.2. Warranty

Kontron defines product warranty in accordance with regional warranty definitions. Claims are at Kontron's discretion and limited to the defect being of a material nature. To find out more about the warranty conditions and the defined warranty period for your region, follow the steps below:

1. Visit Kontron's Term and Conditions webpage.
<http://www.kontron.com/terms-and-conditions>
2. Click on your region's General Terms and Conditions of Sale.

15.2.1. Limitation/Exemption from Warranty Obligation

In general, Kontron shall not be required to honor the warranty, even during the warranty period, and shall be exempted from the statutory accident liability obligations in the event of damage caused to the product due to failure to observe the following:

- ▶ General safety instructions for IT equipment within this user guide.
- ▶ Warning labels on the product and warning symbols within this user guide.
- ▶ Information and hints within this user guide.

Additionally, alterations or modifications to the product that are not explicitly approved by Kontron, described in this user guide, or received from Kontron Support as a special handling instruction will void your warranty.

Due to their limited service life, parts that by their nature are subject to a particularly high degree of wear (wearing parts) are excluded from the warranty beyond that provided by law.

List of Acronyms

Table 45: List of Acronyms

ACPI	Advanced Configuration Power Interface
AHCI	Advanced Host Controller Interface
BIOS	Basic Input Output System
BT	BlueTooth
CE	Conformité Européenne
CFR	Code of Federal Regulations
COM	Communication port
DP	Display Port
DRAM	Dynamic RAM
DVI	Digital Video Interface
ECC	Error Checking and Correction
ECT	Embedded Computer Technology
EEE	Electrical and Electronic Equipment
ESD	Electro Static Device
FCC	Federal Communications Commission
GbE	Giga bit Ethernet
GPU	Graphics Processing Unit
HD	High Definition
HD/HDD	Hard Disk /Drive
ICES	Interference Causing Equipment Standard
IOT	Internet of Things
ITE	Information Technology Equipment
KBD	Keyboard
LAN	Local Area Network
LED	Light-Emitting Diode
LVDs	Low Voltage Device
MDI	Media Dependent Interface
MIMO	Multiple Input Multiple Output
MTBF	Mean Time Before Failure
NC-SI	Network Controller Sideband Interface
PCIe	PCI-Express

mPCIe	Mini PCI-Express
OS	Operating System
PSU	Power Supply Unit
RAID	Redundant Array of Independent Disks
RAM	Random Access memory
REACH	Registration, Evaluation, Authorization and Restriction of Chemicals
RED	Radio Equipment Directive
RMA	Return of Material Authorization
ROHS	Restriction Of Hazardous Substances
RP-SMA	Reverse Polarity SubMiniature Version A
RTC	Real Time Clock
SATA	Serial AT Attachment
mSATA	Mini SATA
SELV	Separate Extra Low Voltage
S.M.A.R.T	Self-Monitoring, Analysis and Reporting Technology
SN	Serial Number
S/PDIF	Sony/Philips Digital Interface
SSD	Solid State Drive
TPM	Trusted Platform Module
UEFI	Unified Extensible Firmware Interface
USB	Universal Serial Bus
VCC	Voltage Common Collector
VDC	Voltage Direct Current
WEEE	Waste Electrical and Electronic Equipment
Wi-Fi	Wireless
WSXGA	Wide Super eXtended Graphics Array
WQXGA	Wide Quad eXtended Graphics Array
XGA	eXtended Graphics Array



About Kontron

Kontron is a global leader in IoT/Embedded Computing Technology (ECT). Kontron offers individual solutions in the areas of Internet of Things (IoT) and Industry 4.0 through a combined portfolio of hardware, software and services. With its standard and customized products based on highly reliable state-of-the-art technologies, Kontron provides secure and innovative applications for a wide variety of industries. As a result, customers benefit from accelerated time-to-market, lower total cost of ownership, extended product lifecycles and the best fully integrated applications.

For more information, please visit: www.kontron.com



GLOBAL HEADQUARTERS

Kontron Europe GmbH
Gutenbergstraße 2
85737 Ismaning
Germany
Tel.: +49 821 4086-0
Fax: +49 821 4086-111
info@kontron.com