



# AL Pi-Tron CM4

Doc. Rev. 1.0

**kontron**

This page has been intentionally left blank

## ▶ AL PI-TRON CM4 - USER GUIDE

### Disclaimer

Kontron Electronics would like to point out that the information contained in this user guide may be subject to alteration, particularly as a result of the constant upgrading of Kontron Electronics products. This document does not entail any guarantee on the part of Kontron Electronics with respect to technical processes described in the user guide or any product characteristics set out in the user guide. Kontron Electronics assumes no responsibility or liability for the use of the described product(s), conveys no license or title under any patent, copyright or mask work rights to these products and makes no representations or warranties that these products are free from patent, copyright or mask work right infringement unless otherwise specified. Applications that are described in this user guide are for illustration purposes only. Kontron Electronics makes no representation or warranty that such application will be suitable for the specified use without further testing or modification. Kontron Electronics expressly informs the user that this user guide only contains a general description of processes and instructions which may not be applicable in every individual case. In cases of doubt, please contact Kontron Electronics.

This user guide is protected by copyright. All rights are reserved by Kontron Electronics. No part of this document may be reproduced, transmitted, transcribed, stored in a retrieval system, or translated into any language or computer language, in any form or by any means (electronic, mechanical, photocopying, recording, or otherwise), without the express written permission of Kontron Electronics. Kontron Electronics points out that the information contained in this user guide is constantly being updated in line with the technical alterations and improvements made by Kontron Electronics to the products and thus this user guide only reflects the technical status of the products by Kontron Electronics at the time of publishing.

Brand and product names are trademarks or registered trademarks of their respective owners.

©2023 by Kontron Electronics GmbH

### YOUR CONTACT

Kontron Electronics GmbH

Max-Planck-Str. 6  
72636 Frickenhausen  
Germany  
[www.kontron-electronics.com](http://www.kontron-electronics.com)

### GLOBAL HEADQUARTERS

Kontron Europe GmbH

Gutenbergstr. 2  
85737 Ismaning  
Germany  
[www.kontron.com](http://www.kontron.com)

## Intended Use

**THIS DEVICE AND ASSOCIATED SOFTWARE ARE NOT DESIGNED, MANUFACTURED OR INTENDED FOR USE OR RESALE FOR THE OPERATION OF NUCLEAR FACILITIES, THE NAVIGATION, CONTROL OR COMMUNICATION SYSTEMS FOR AIRCRAFT OR OTHER TRANSPORTATION, AIR TRAFFIC CONTROL, LIFE SUPPORT OR LIFE SUSTAINING APPLICATIONS, WEAPONS SYSTEMS, OR ANY OTHER APPLICATION IN A HAZARDOUS ENVIRONMENT, OR REQUIRING FAIL-SAFE PERFORMANCE, OR IN WHICH THE FAILURE OF PRODUCTS COULD LEAD DIRECTLY TO DEATH, PERSONAL INJURY, OR SEVERE PHYSICAL OR ENVIRONMENTAL DAMAGE (COLLECTIVELY, "HIGH RISK APPLICATIONS").**

You understand and agree that your use of Kontron Electronics devices as a component in High-Risk Applications is entirely at your risk. To minimize the risks associated with your products and applications, you should provide adequate design and operating safeguards. You are solely responsible for compliance with all legal, regulatory, safety, and security related requirements concerning your products. You are responsible to ensure that your systems (and any Kontron Electronics hardware or software components incorporated in your systems) meet all applicable requirements. Unless otherwise stated in the product documentation, the Kontron Electronics device is not provided with error-tolerance capabilities and cannot therefore be deemed as being engineered, manufactured or setup to be compliant for implementation or for resale as device in High-Risk Applications. All application and safety related information in this document (including application descriptions, suggested safety measures, suggested Kontron Electronics products, and other materials) is provided for reference only.

## Revision History

Revision	Brief Description of Changes	Date of Issue	Author/Editor
Rev. 0.1	Initial version	2023-03-01	Tur
Rev. 1.0	Final release	2023-05-17	Tur

## Terms and Conditions

Kontron Electronics warrants products in accordance with defined regional warranty periods. For more information about warranty compliance and conformity, and the warranty period in your region, visit <https://www.kontron-electronics.de/downloads/>.

For contact information, refer to the corporate offices contact information on the last page of this user guide or visit our website [CONTACT US](#).

## Customer Support

Find Kontron Electronics contacts by visiting: <http://www.kontron-electronics.com/>

## Customer Comments

If you have any difficulties using this user guide, discover an error, or just want to provide some feedback, contact [support@kontron-electronics.de](mailto:support@kontron-electronics.de). Detail any errors you find. We will correct the errors or problems as soon as possible and provide the revised user guide.

## Symbols

The following symbols may be used in this user guide

### **⚠ DANGER**

DANGER indicates a hazardous situation which, if not avoided, will result in death or serious injury.

### **⚠ WARNING**

WARNING indicates a hazardous situation which, if not avoided, could result in death or serious injury.

### **NOTICE**

NOTICE indicates a property damage message.

### **⚠ CAUTION**

CAUTION indicates a hazardous situation which, if not avoided, may result in minor or moderate injury.



#### **Electric Shock!**

This symbol and title warn of hazards due to electrical shocks (> 60 V) when touching products or parts of products. Failure to observe the precautions indicated and/or prescribed by the law may endanger your life/health and/or result in damage to your material.



#### **ESD Sensitive Device!**

This symbol and title inform that the electronic boards and their components are sensitive to static electricity. Care must always therefore be taken during all handling operations and inspections of this product in order to ensure product integrity at all times.



#### **HOT Surface!**

Do NOT touch! Allow to cool before servicing.



#### **Laser!**

This symbol informs of the risk of exposure to laser beam and light emitting devices (LEDs) from an electrical device. Eye protection per manufacturer notice shall review before servicing.



This symbol indicates general information about the product and the user guide.

This symbol also indicates detail information about the specific product configuration.



This symbol precedes helpful hints and tips for daily use.

## For Your Safety

Your new Kontron Electronics product was developed and tested carefully to provide all features necessary to ensure its compliance with electrical safety requirements. It was also designed for a long fault-free life. However, the life expectancy of your product can be drastically reduced by improper treatment during unpacking and installation. Therefore, in the interest of your own safety and of the correct operation of your new Kontron Electronics product, you are requested to conform with the following guidelines.

### High Voltage Safety Instructions

As a precaution and in case of danger, the power connector must be easily accessible. The power connector is the product's main disconnect device.

---

**⚠ CAUTION****Warning**

All operations on this product must be carried out by sufficiently skilled personnel only.

---

**⚠ CAUTION****Electric Shock!**

Before installing a non-hot-swappable Kontron Electronics product into a system always ensure that the power is switched off. This also applies to the installation of piggybacks. Serious electrical shock hazards can exist during all installation, repair, and maintenance operations on this product. Therefore, always unplug the power cable and any other cables which provide external voltages before performing any work on this product.

Earth ground connection to vehicle's chassis or a central grounding point shall remain connected. The earth ground cable shall be the last cable to be disconnected or the first cable to be connected when performing installation or removal procedures on this product.

---

## General Safety Instructions for IT Equipment

### **⚠ WARNING**



Please read this chapter carefully and take careful note of the instructions that have been compiled for your safety and to ensure to apply in accordance with intended regulations. If the following general safety instructions are not observed, it could lead to injuries to the operator and/or damage of the product; in cases of non-observance of the instructions Kontron Electronics is exempt from accident liability, this also applies during the warranty period.

The product has been built and tested according to the basic safety requirements for low voltage (LVD) applications and has left the manufacturer in safety-related, flawless condition. To maintain this condition and to ensure safe operation, the operator must not only observe the correct operating conditions for the product but also the following general safety instructions:

- ▶ The product must be used as specified in the product documentation, in which the instructions for safety for the product and for the operator are described. These contain guidelines for setting up, installation and assembly, maintenance, transport and storage.
- ▶ The on-site electrical installation must meet the requirements of the country's specific local regulations.
- ▶ If a power cable comes with the product, only this cable should be used. Do not use an extension cable to connect the product.
- ▶ To guarantee that enough air circulation is available to cool the product, ensure that if the product has ventilation openings the openings are not covered or blocked. If an air filter is provided, this should be cleaned regularly. Additionally, make sure the system is well ventilated by observing if heat-dissipating elements are covered/obstructed by objects as this can cause a build-up of heat and stop heat from being dispersed into the ambient environment.
- ▶ Do not place the system close to heat sources or damp places.
- ▶ Only products or parts which fulfil the requirements of SELV circuits (Safety Extra Low Voltage) as stipulated by IEC 60950-1 may be connected to the available interfaces.
- ▶ Before opening the product, make sure that the product is disconnected from the mains. Complete disconnection is only possible if the power cable is disconnected and removed. Ensure that there is free and easy access to enable disconnection.
- ▶ If the product is opened for the insertion or removal of expansion devices (depending on the configuration of the system), this may only be carried out by qualified persons.
- ▶ If extensions are made to the product, the following must be observed:
  - ▶ All effective legal regulations and all technical data for the expansion devices are adhered to.
  - ▶ The power consumption of any expansion devices does not exceed the specified limitations.
  - ▶ The current consumption of the system does not exceed the value stated on the product label.
- ▶ Only original accessories that have been approved by Kontron Electronics can be used.
- ▶ Please note: safe operation is no longer possible when any of the following applies:
  - ▶ Damage is visible.
  - ▶ The device no longer functions.

In these cases, the device must be switched off and it must be ensured that the device can no longer be operated.



## Additional Safety Instructions for DC Power Supply Circuits

- ▶ To guarantee safe operation of products with DC power supply voltages larger than 60 volts DC or a power consumption larger than 240 VA, please observe that:
  - ▶ The product is set up, installed and operated in a room or enclosure marked with "RESTRICTED ACCESS", if there are no safety messages on product as safety signs and labels on the product itself.
  - ▶ No cables or parts without insulation in electrical circuits with dangerous voltage or power should be touched directly or indirectly.
  - ▶ A reliable protective earthing connection is provided.
  - ▶ A suitable, easily accessible disconnecting product is used in the application (e.g. overcurrent protective product), if the product itself is not disconnectable.
  - ▶ A disconnect product, if provided in or as part of the equipment, shall disconnect both poles simultaneously.
  - ▶ Interconnecting power circuits of different products causes no electrical hazards.
- ▶ A sufficient dimensioning of the power cable wires must be selected – according to the maximum electrical specifications on the product label – as stipulated by EN 60950-1 or VDE 0100 or EN 60204 or UL 508 regulations.
- ▶ The product does not generally fulfil the requirements for "centralized DC power systems" (UL 60950-1, Annex NAB; D2) and therefore may not be connected to such products!

## Special Handling and Unpacking Instruction

### NOTICE



#### ESD Sensitive Device!

Electronic boards and their components are sensitive to static electricity. Therefore, care must be taken during all handling operations and inspections of this product, in order to ensure product integrity at all times.

Do not handle this product out of its protective enclosure while it is not used for operational purposes unless it is otherwise protected.

Whenever possible, unpack or pack this product only at EOS/ESD safe workstations. Where a safe workstation is not guaranteed, it is important for the user to be electrically discharged before touching the product with his/her hands or tools. This is most easily done by touching a metal part of your system housing.

It is particularly important to observe standard anti-static precautions when changing piggybacks, ROM devices, SD cards, jumper settings etc. If the product contains batteries for RTC or memory backup, ensure that the product is not placed on conductive surfaces, including anti-static plastics or sponges. They can cause short circuits and damage the batteries or conductive circuits on the product.

## Lithium Battery Precautions

If your product is equipped with a lithium battery, take the following precautions when replacing the battery.

### ⚠ CAUTION

---

**Danger of explosion if the battery is replaced incorrectly.**

- ▶ Replace only with same or equivalent battery type recommended by the manufacturer.
  - ▶ Dispose of used batteries according to the manufacturer's instructions.
- 

## General Instructions on Usage

In order to maintain Kontron Electronics' product warranty, this product must not be altered or modified in any way. Changes or modifications to the product, that are not explicitly approved by Kontron Electronics and described in this user guide or received from Kontron Electronics Support as a special handling instruction, will void your warranty.

This product should only be installed in or connected to systems that fulfil all necessary technical and specific environmental requirements. This also applies to the operational temperature range of the specific board version that must not be exceeded. If batteries are present, their temperature restrictions must be considered.

In performing all necessary installation and application operations, only follow the instructions supplied by the present user guide.

Keep all the original packaging material for future storage or warranty shipments. If it is necessary to store or ship the product then re-pack it in the same manner as it was delivered.

Special care is necessary when handling or unpacking the product. See Special Handling and Unpacking Instruction.

## Quality and Environmental Management

Kontron Electronics aims to deliver reliable high-end products designed and built for quality, and aims to complying with environmental laws, regulations, and other environmentally oriented requirements. For more information regarding Kontron Electronics' quality and environmental responsibilities, visit

<https://www.kontron-electronics.com/company/about-us/germany/>

## Disposal and Recycling

Kontron Electronics' products are manufactured to satisfy environmental protection requirements where possible. Many of the components used are capable of being recycled. Final disposal of this product after its service life must be accomplished in accordance with applicable country, state, or local laws or regulations.

## WEEE Compliance

The Waste Electrical and Electronic Equipment (WEEE) Directive aims to:

- ▶ Reduce waste arising from electrical and electronic equipment (EEE).
- ▶ Make producers of EEE responsible for the environmental impact of their products, especially when the product become waste.
- ▶ Encourage separate collection and subsequent treatment, reuse, recovery, recycling and sound environmental disposal of EEE.
- ▶ Improve the environmental performance of all those involved during the lifecycle of EEE.



---

**Environmental protection is a high priority with Kontron Electronics.**  
**Kontron Electronics follows the WEEE directive.**  
**You are encouraged to return our products for proper disposal.**

---

# Table of Contents

Symbols .....	6
For Your Safety .....	7
High Voltage Safety Instructions .....	7
Special Handling and Unpacking Instruction .....	9
Lithium Battery Precautions .....	10
General Instructions on Usage .....	10
Quality and Environmental Management .....	10
Disposal and Recycling .....	10
WEEE Compliance .....	10
Table of Contents .....	11
List of Tables .....	13
List of Figures .....	13
1/ Introduction .....	14
1.1. Product Overview .....	14
1.2. Ordering Information .....	15
1.3. Accessories .....	15
2/ Specification .....	16
2.1. Technical Specification .....	16
2.2. Mechanical Specification .....	16
2.3. Power Specification .....	19
2.3.1. Power Consumption .....	19
2.3.2. Functional Earthing System .....	20
2.3.3. Environmental Specification .....	20
2.4. Block Diagram .....	21
3/ Connector Description .....	22
3.1.1. Power Connector .....	23
3.1.2. HDMI Interface .....	23
3.1.3. Ethernet (LAN2, LAN1) Interface .....	23
3.1.4. USB 2.0 Interface .....	23
3.1.5. RS232 Interface .....	23
3.1.6. RS485 Interface .....	23
3.1.7. CAN Interface .....	23
3.1.8. DIO Interface .....	24
3.1.9. Debug Interface .....	24
3.1.10. USB OTG Interface .....	24
3.1.11. MicroSD Card Slot .....	24
3.1.12. Functional Earth Connector .....	24
3.2. Connector Pin Assignments .....	25
3.2.1. Input Power Connector (X1) .....	25
3.2.2. HDMI Connector (X80) .....	25
3.2.3. Ethernet RJ45 Connector (X20) .....	26
3.2.4. Ethernet RJ45 Connector (X21) .....	26
3.2.5. USB Connector (X10) .....	26
3.2.6. RS232 Connector (X30) .....	27
3.2.7. RS485/CAN Connector (X40) .....	27
3.2.8. DIO Connector (X50) .....	27
3.2.9. USB Debug Connector (X70) .....	28
3.2.10. USB OTG Connector (X60) .....	29
3.2.11. MicroSD Card Slot (microSD) .....	29
4/ Accessing Components .....	30

4.1. Accessing External Components .....	30
4.1.1. MicroSD Card Slot .....	30
4.2. Accessing Internal Components .....	30
4.2.1. Opening the Chassis .....	30
5/ Thermal Considerations.....	31
6/ Installation Instructions.....	32
6.1. DIN Rail Mounting .....	32
6.2. Power Connector .....	32
6.2.1. Wiring the DC Mating Power Connector .....	32
7/ Starting Up.....	33
7.1. Connecting to Power Supply .....	33
7.2. Operating System (OS) and Drivers.....	33
8/ Standards, Certifications and Directives .....	34
9/ Shipment and Unpacking .....	35
9.1. Packaging.....	35
9.2. Unpacking .....	35
9.3. Type Label and Product Identification.....	35
10/ Technical Support .....	36
10.1. First Steps – Startup-Information Baseboard.....	36
10.2. Extended Support.....	36
10.3. Disclaimer & License Information .....	36
11/ Storage, Transportation and Maintenance.....	37
11.1. Storage.....	37
11.2. Transportation .....	37
11.3. Maintenance.....	37
11.3.1. Replacing the Lithium Battery .....	37
12/ Warranty .....	38
12.1. Limitation/Exemption from Warranty Obligation.....	38
13/ Disposal.....	39
Appendix.....	40
List of Acronyms.....	40
About Kontron Electronics .....	41

## List of Tables

Table 1: Scope of Delivery .....	15
Table 2: Accessories .....	15
Table 3: Technical Specification .....	16
Table 4: Software Specification.....	16
Table 5: Mechanical Specification.....	16
Table 6: Power Specification .....	19
Table 7: Power Consumption.....	20
Table 8: Environmental Specification.....	20
Table 9: Front Panel Connectors .....	22
Table 10: Standards, Certifications and Directives Compliance.....	34
Table 11: List of Acronyms .....	40

## List of Figures

Figure 1: AL Pi-Tron CM4 .....	14
Figure 2: Bottom view .....	17
Figure 3: Front view .....	17
Figure 4: Rear view.....	17
Figure 5: Side views .....	18
Figure 6: Power Tree .....	19
Figure 7: Block Diagram.....	21
Figure 8: Front Panel View .....	22
Figure 9: UART-USB Adapter .....	28
Figure 10: Phoenix Power Mating Connector .....	32
Figure 11: AL Pi-Tron CM4 Type Label (Example) .....	35

# 1/ Introduction

This user guide describes the Automation Line AL Pi-Tron CM4. New users are recommended to study the installation instructions within this user guide before switching on the power.

Kontron Electronics' AL Pi-Tron CM4 is developed specifically for control cabinet applications with flexible DIN rail mounting positions for use when space is limited. The fanless design ensures a significantly prolonged lifespan and high system availability.

## 1.1. Product Overview

Before working with the AL Pi-Tron CM4, Kontron Electronics recommends that users take a few minutes to learn about the various parts of the AL Pi-Tron CM4.

The AL Pi-Tron CM4 is a flexible industrial grade box computer, a fanless device designed for use in demanding applications requiring a flexible DIN rail attachment solution. Based on the CM4 Broadcom BCM2711 quad-core Cortex-A72 (ARM v8) 64-bit SoC processor, the AL Pi-Tron CM4 features long-term availability and supports a varied number of onboard interfaces to enable connectivity to nearly all applications. The microSD card slot serves either as boot device or offers memory expansion for flexible data storage.

All variants are available in a robust steel chassis, designed for operation in a DIN rail environment using a vertical orientation.

General features are:

- ▶ Broadcom BCM2711 quad-core Cortex-A72 (ARM v8) 64-bit SoC
- ▶ 1 GB up to 8 GB LPDDR4 RAM
- ▶ 8 GB up to 32 GB eMMC
- ▶ External microSD Card Slot
- ▶ External Interfaces 1x HDMI, 2x Ethernet (1x Gbit/s, 1x 10/100 Mbit/s), 2x USB 2.0, 1x USB OTG, 1x RS232, 1x RS485, 1x CAN, 4x DIO (24 V / up to 800 mA)
- ▶ Fanless passive cooling

The AL Pi-Tron CM4 is intended for 24/7 continuous operation and longtime industrial applications. All components are selected to ensure a long lifetime.

Figure 1: AL Pi-Tron CM4



---

The AL Pi-Tron CM4 is designed for operation in a DIN rail environment using a vertical orientation.

---

## 1.2. Ordering Information

Check that your delivery is complete, and contains the items listed below. If you discover damaged or missing items, contact your dealer.

**Table 1: Scope of Delivery**

Art.-No.	Delivered Item	Description
50099 081	AL Pi-Tron CM4 2GB/16GB eMMC	Corresponding to the ordered product configuration
	Other systems on request	

## 1.3. Accessories

**Table 2: Accessories**

Art.-No.	Delivered Item	Description
1 060 0338	MicroSD Card	MicroSD Card 16 GB
30099 001	Power Supply	External power supply 230 V AC to 24 V DC / 18 W incl. 2-pin power connector (Phoenix Contact origin no. 1826680)
30099 003	Connector Set 24VDC/RS232/RS485/CAN/DIO mating connector	Connector set contains: 1x 2-pin power connector (Phoenix Contact origin no. 1826680) 1x RS232: 8-pin; 1x RS485/CAN: 8-pin; 1x DIO: 8-pin (Phoenix Contact origin no. 1844594)
40099 101	USB-UART Adapter	Translates the UART signals provided on the Mini-B USB connector to USB for connecting the AL Pi-Tron CM4 to a computer

## 2/ Specification

### 2.1. Technical Specification

The AL Pi-Tron CM4 implements the following mainboard technical specification.

**Table 3: Technical Specification**

<b>Processor</b>	4x ARM Cortex®-A72, 64-bit SoC @1,5 GHz
<b>System Memory</b>	LPDDR4-RAM 1 GB up to 8 GB
<b>Storage</b>	8 GB eMMC up to 32 GB 32 kbit EEPROM
<b>Interfaces</b>	2x USB 2.0, USB A 1x USB OTG, Micro-USB 1x Debug, Mini-B USB 1x 1 Gbit/s, 1x 10/100 Mbit/s Ethernet, RJ45 1x HDMI 1x RS232, 1x RS485 1x CAN FD 4x DIO (24 V DC / up to 800 mA)
<b>Expansion Sockets</b>	1x microSD Card Slot
<b>Power</b>	24 V DC ±20 % Input

**Table 4: Software Specification**

<b>Operating System (OS)</b>	Raspberry Pi OS (Raspbian), Yocto, Windows IOT, Ubuntu Desktop/Server/Core, LibreElec, RetroPie and others  Documentation and support: <a href="https://docs.kontron-electronics.de">https://docs.kontron-electronics.de</a>
------------------------------	--

### 2.2. Mechanical Specification

**Table 5: Mechanical Specification**

Dimensions	AL Pi-Tron CM4
<b>Width</b>	111 mm (4.37")
<b>Depth</b>	76 mm (3")
<b>Height</b>	25 mm (1")
<b>Weight (chassis only)</b>	Approx. ~0.3 kg (~0.66 lbs.)
<b>Construction</b>	Stainless Steel housing
<b>Mounting</b>	DIN Rail
<b>Color</b>	Stainless Steel

For more detailed mechanical information, refer to the following outline dimensions drawings within this chapter. Each dimension drawing shows the main external mechanical features such as the position and size of mounting holes for the DIN rail mounting clamp (measurements in millimetres).

The DIN rail mounting clamp is 7 mm thick.



Figure 2: Bottom view

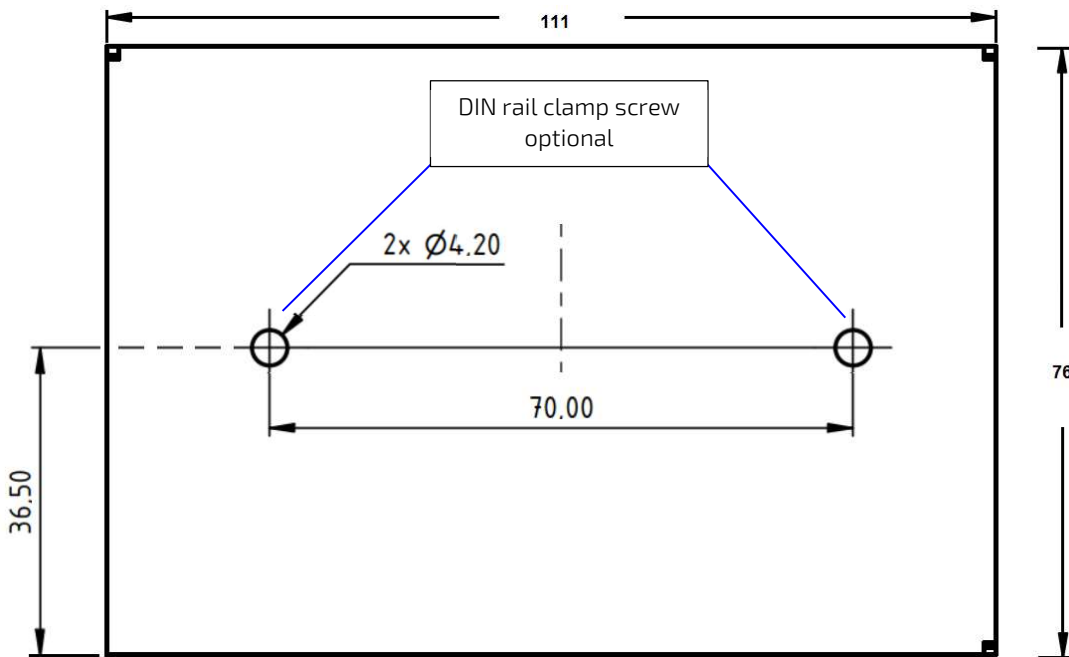

Figure 3: Front view

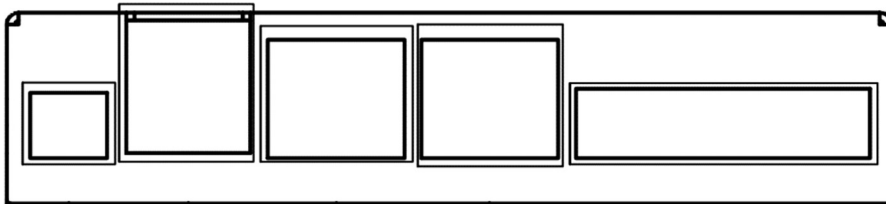

Figure 4: Rear view

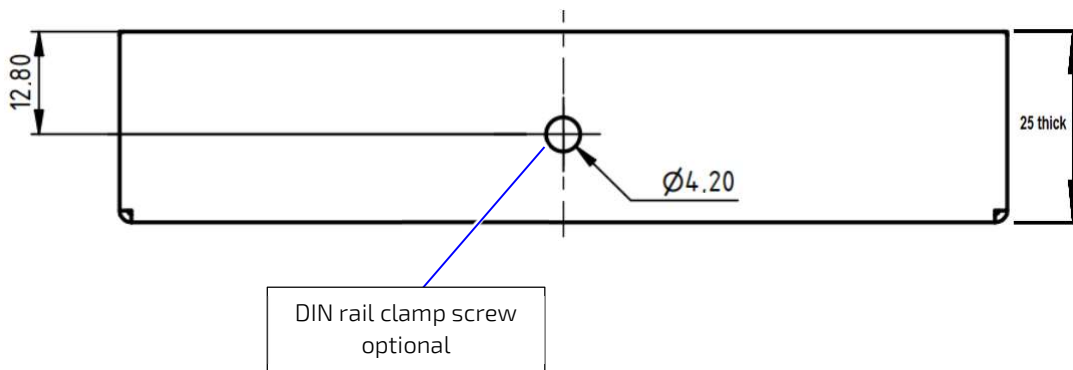
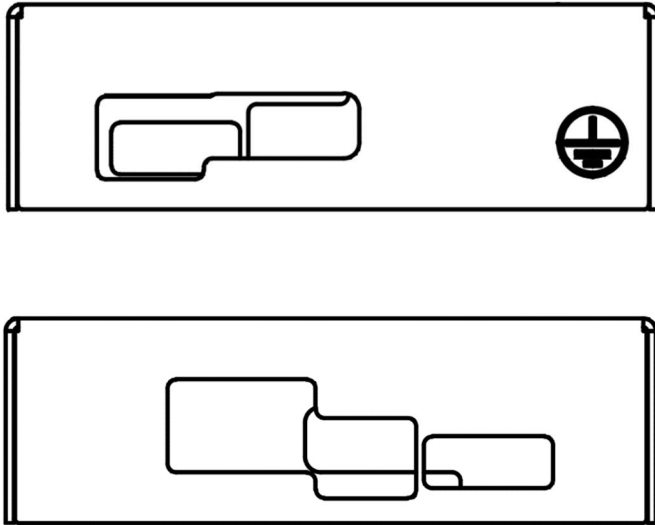

Figure 5: Side views



## 2.3. Power Specification

The AL Pi-Tron CM4 is powered by a 2-pin input power connector on the front panel and has no internal power supply. The standard input voltage of 24 V DC is converted internally to supply all other required voltages.

**NOTICE** Hot Plugging the power supply is not supported. Hot plugging might damage the board.

Table 6: Power Specification

Nominal Input Voltage	24 V DC
Nominal Power Consumption	4 W
Input Voltage Range	24 V DC $\pm$ 20 %
Input Power	max. 8 A (connector current)
Output Current 5 V	2 A
Output Current DOUT	2 A
Input Power Mating Connector	Phoenix Contact Connector 180° FMC 1,5/2-ST-3,5 (Phoenix 1826680)

### 2.3.1. Power Consumption

The power consumption of the AL Pi-Tron CM4 depends on the implemented mainboard capacity and external interfaces, for more information see Table 7: Power Consumption.

Figure 6: Power Tree

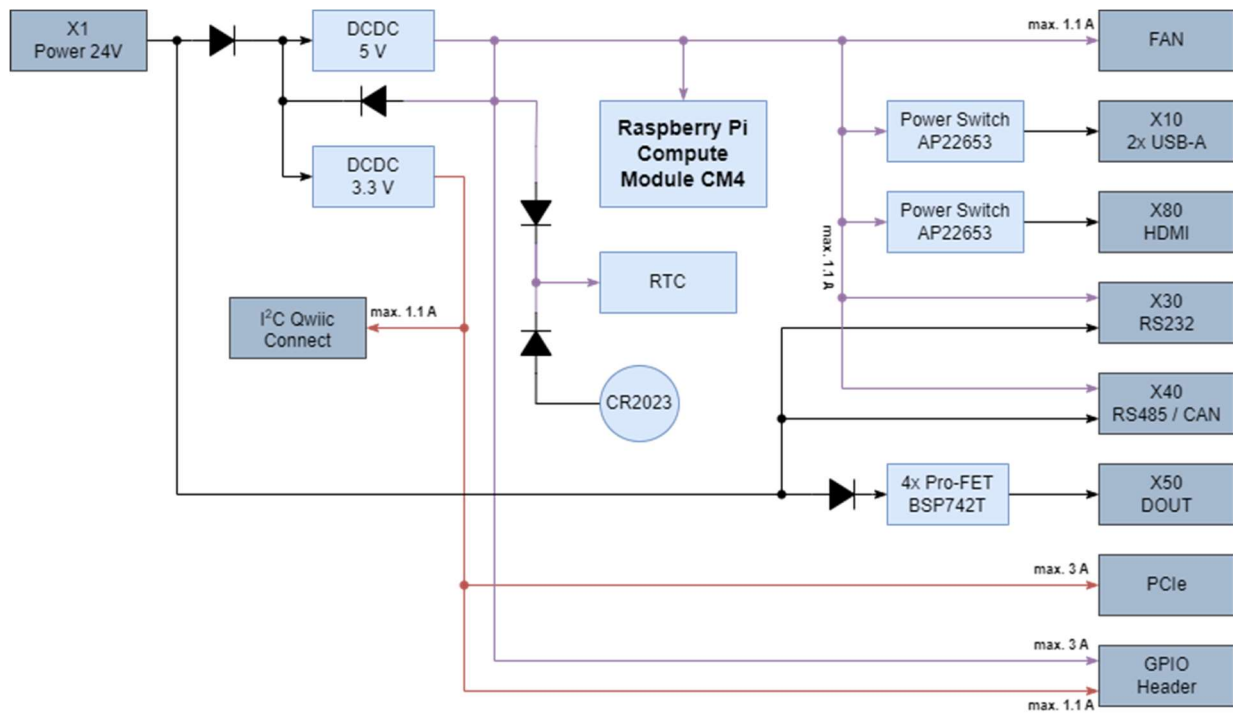

Table 7: Power Consumption

Power Figures	AL Pi-Tron CM4
Pi-Tron CM4 Deep Sleep Mode	not supported
Pi-Tron CM4 idle default	3 W
Pi-Tron CM4 run	5 W
LAN 1	0,1 W
LAN 2	0,1 W
2x USB 2.0	$2 \times 5 \text{ V} * 500 \text{ mA} = 5,5 \text{ W}$
4x DOUT	$2,5 \text{ A} * 24 \text{ V} = 60 \text{ W}$

### 2.3.2. Functional Earthing System

There is a functional earth self-clinching nut on the side of the housing connected to the electronic ground inside the system and to the mounting clamp on the backside.

### 2.3.3. Environmental Specification

Table 8: Environmental Specification

Temperature (Operating)	0...55 °C ambient
Relative Humidity (Operating)	93 % @40 °C, non-condensing
Pollution Degree	Class II

## 2.4. Block Diagram

Figure 7: Block Diagram

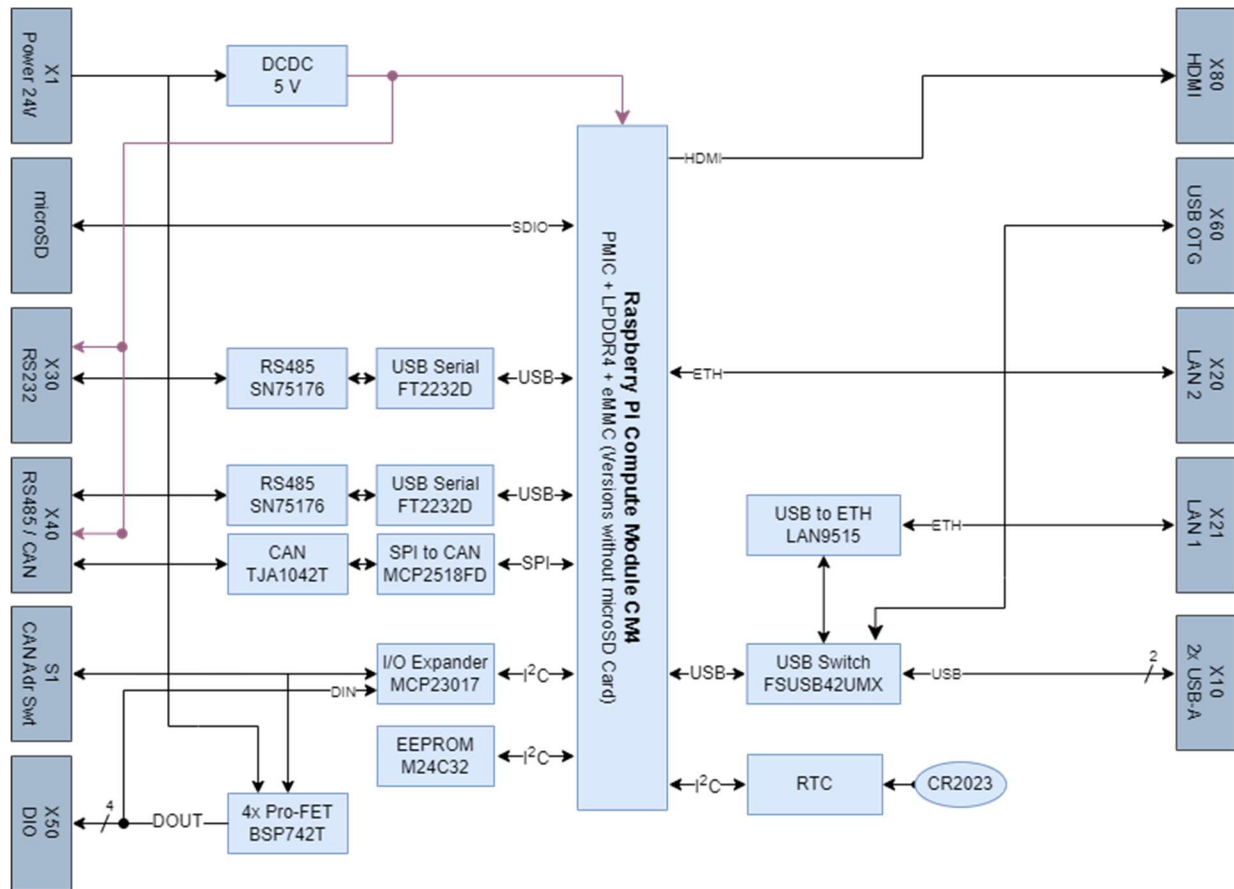

### 3/ Connector Description

The front panel includes most of the I/O connectors.

Figure 8: Front Panel View

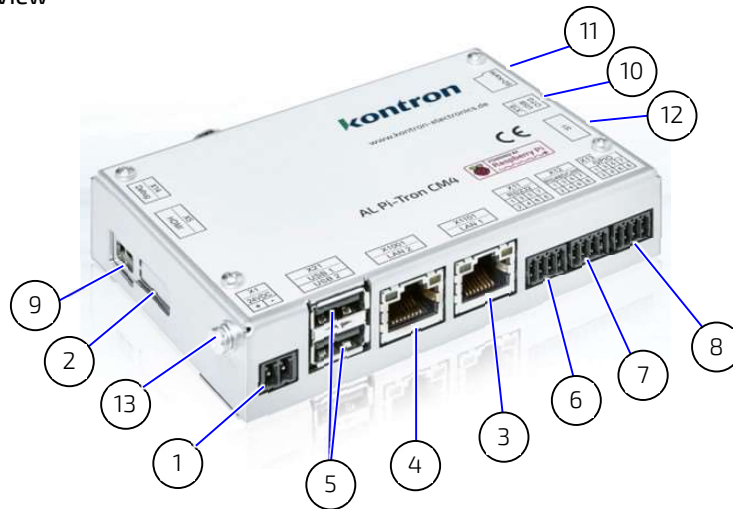

Table 9: Front Panel Connectors

Item	Label	Function	See Chapter
1	X1	DC Power Connector (2-pin Phoenix Contact)	3.2.1
2	X80	HDMI Connector	3.2.2
3	X20	1 Gbit/s LAN2 RJ-45 Connector	3.2.3
4	X21	10/100 Mbit/s LAN1 RJ-45 Connector	3.2.4
5	X10	USB 2.0 Port 0 / 1 Connector (upper / lower)	3.2.5
6	X30	RS232 Connector	3.2.6
7	X40	RS485 / CAN Connector	3.2.7
8	X50	DIO Connector	3.2.8
9	X70	Debug UART Connector	3.2.9
10	X60	USB OTG Connector	3.2.10
11	microSD	MicroSD Card Slot	3.2.11
12	S1	Switch CAN Address	3.2.7
13	FE	Functional Earth Connector	3.1.12

### 3.1.1. Power Connector

There is one 2-pin power connector on the front panel supporting an input DC voltage of 24 V DC  $\pm$ 20 %, see Figure 8 (pos. 1). The mating connector required to connect the power connector to a DC main power source is delivered with the AL Pi-Tron CM4. For information on how to connect the mating connector to the front panel input power connector, refer to Chapter 6.2.1: Wiring the DC Mating Power Connector.

For the pin assignment of the input power connector, refer to Chapter 3.2.1: Input Power Connector.

### 3.1.2. HDMI Interface

There is one HDMI interface (up to 4k resolution) for video solutions, see Figure 8 (pos. 2). The HDMI interface is not designed for connecting cables longer than 3 m.

For the pin assignment of the HDMI connector, refer to Chapter 3.2.2 HDMI Connector (X80).

### 3.1.3. Ethernet (LAN2, LAN1) Interface

There are two LAN ports, see Figure 8 (pos. 3 and 4). In the software these are referred to as ETH0 and ETH1. The assignment between LAN2/LAN1 and ETH0/ETH1 depends on the software.

Note: The LAN2 port is connected directly to the CM4 ethernet, whereas LAN1 is connected to a 10/100 Mbit/s USB-Ethernet controller.

In order to achieve the specified performance of the Ethernet port, shielded category 5 twisted pair cables must be used with 10/100 Mbit/s and Category 5E, 6 or 6E with 1 Gbit/s LAN networks.

For the pin assignment of the RJ45 Ethernet connectors, refer to Chapter 3.2.3: Ethernet RJ45 Connector (X20).

### 3.1.4. USB 2.0 Interface

There are two USB 2.0 ports allowing the connection of USB 2.0 compatible devices, see Figure 8 (pos. 5). The USB ports are designed for connecting short cables only.

For the pin assignment of the USB 2.0 connector, refer to Chapter 3.2.5: USB Connector (X10).

### 3.1.5. RS232 Interface

There is a RS232 interface (RX/TX) supporting RTS/CTS, see Figure 8 (pos. 6). The RS232 interface is not designed for connecting cables longer than 3 m.

For the pin assignment of the RS232 connector, refer to Chapter 3.2.6: RS232 Connector (X30).

### 3.1.6. RS485 Interface

The connector for RS485 (see Figure 8 pos. 7) also contains the wiring for CAN. The RS485 interface is not designed for connecting cables longer than 30 m. This interface switches automatically between receiving and sending.

For the pin assignment of the RS485/CAN connector, refer to Chapter 3.2.7: RS485/CAN Connector (X40).

### 3.1.7. CAN Interface

The connector for CAN (see Figure 8 pos. 7) also contains the wiring for RS485. The CAN address switches 1...4 are connected to a GPIO expander and can therefore also be used for other purposes. The CAN interface is not designed for connecting cables longer than 30 m.

For the pin assignment of the RS485/CAN connector, refer to Chapter 3.2.7: RS485/CAN Connector (X40).

### 3.1.8. DIO Interface

There is a four port DIO interface available on the front panel of the AL Pi-Tron CM4, see Figure 8 (pos. 8).

The DIO pins consist of a 24 V high side switch, capable of driving up to 800 mA. The voltage level is according to the supply voltage. When the output is disabled, the pin can be used as 24 V input. The DIO interface is not designed for connecting cables longer than 30 m.

For the pin assignment of the DIO connector, refer to Chapter 3.2.8: DIO Connector (X50).

### 3.1.9. Debug Interface

There is a Debug interface using UART protocol with a Mini-B USB connector, see Figure 8 (pos. 9).

An additional adapter is needed to translate the 3.3 V UART signals (provided on the Mini-B USB connector) to USB. The debug interface is for service purposes and should only be used by qualified personnel.

For the pin assignment of the debug connector, refer to Chapter 3.2.9: USB Debug Connector (X70).

### 3.1.10. USB OTG Interface

There is a Micro-USB OTG connector that can be used for programming the CM4s eMMC, see Figure 8 (pos. 10).

The USB OTG interface is for service purpose and should only be used by qualified personnel.

For the pin assignment of the USB OTG connector, refer to Chapter 3.2.10: USB OTG Connector (X60).

### 3.1.11. microSD Card Slot

The Pi-Tron CM4 can be obtained with two different types of Compute Module. One without *eMMC* memory, the "*Lite*" version, and the "*eMMC*" version. The notable difference between the *Lite* and the *eMMC* Compute Module is that the "*Lite*" version can only boot and use the microSD card and the "*eMMC*" version can only boot from *eMMC* memory but use the microSD card as a memory expansion when activated via software switch. For the location of the microSD card slot, see Figure 8 (pos. 11).

For the pin assignment of the microSD card slot, refer to Chapter 3.2.11: microSD Card.



---

**Pay attention to the manufacturer's lifespan specification. Due to the limited lifespan of microSD cards/SSD drives Kontron Electronics recommends checking the condition regularly.**

---

### 3.1.12. Functional Earth Connector

The GND pin of the power connector is connected to functional earth of the electronics, to the mounting clamp and to the metal housing of the AL Pi-Tron CM4.



## 3.2. Connector Pin Assignments

### 3.2.1. Input Power Connector (X1)

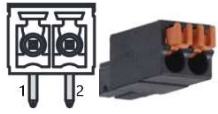
2-Pin Power Mating Connector	Pin	Signal Name
	1	VCC
	2	GND

Phoenix Contact Connector 180° FMC 1,5/2-ST-3,5 (Phoenix 1826680)

### 3.2.2. HDMI Connector (X80)

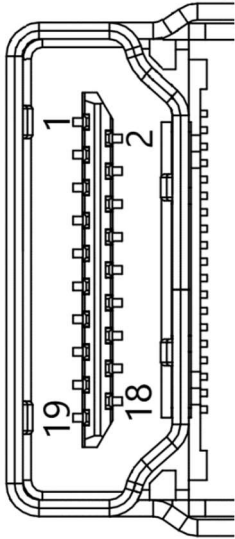
HDMI	Pin	Signal Name
	1	TMDS Data2+
	2	GND
	3	TMDS Data2-
	4	TMDS Data1+
	5	GND
	6	TMDS Data1-
	7	TMDS Data0+
	8	GND
	9	TMDS Data0-
	10	TMDS Clock+
	11	GND
	12	TMDS Clock-
	13	Reserved
	14	Reserved
	15	DDC_CLK
	16	DDC_DATA
	17	GND
	18	+5 V Power
	19	Hot Plug Detect

### 3.2.3. Ethernet RJ45 Connector (X20)

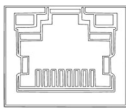
RJ45 (female)	Pin	Signal Name	Pin	Signal Name
	1	TX0+	5	TX2-
	2	TX0-	6	TX1-
	3	TX1+	7	TX3+
	4	TX2+	8	TX3-

Left LED: Activity / Link		Right LED: Activity 10/100/1000	
Off	10 Mbit/s	Off	No LAN connectivity
Green	100 Mbit/s, 1000 Mbit/s	Yellow	Link
		Blinking	Activity

### 3.2.4. Ethernet RJ45 Connector (X21)

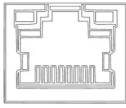
RJ45 (female)	Pin	Signal Name	Pin	Signal Name
	1	TX+	5	n.c.
	2	TX-	6	RX-
	3	RX+	7	n.c.
	4	n.c.	8	n.c.

Left LED: Activity / Link		Right LED: Activity 10/100	
Off	10 Mbit/s	Off	No LAN connectivity
Green	100 Mbit/s	Yellow	Link
		Blinking	Activity

### 3.2.5. USB Connector (X10)

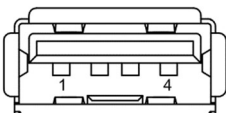
2x USB A 2.0	Pin	Signal Name
	1	+USB_VCC
	2	D-
	3	D+
	4	GND

### 3.2.6. RS232 Connector (X30)

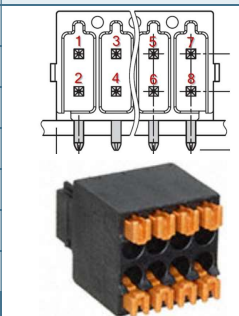
RS232 Interface	Pin	RS232
	1	VIN
	2	GND
	3	TxD
	4	RxD
	5	RTD
	6	CTS
	7	+5 V DC
	8	GND

Phoenix Contact Connector 180° DFMC 0,5/4-ST-2,54 (Phoenix 1844594)

### 3.2.7. RS485/CAN Connector (X40)

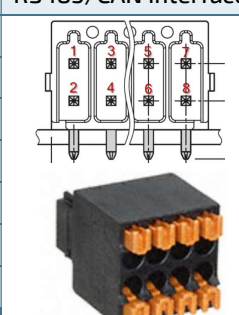
RS485/CAN Interface	Pin	Signal Name
	1	VIN
	2	GND
	3	RS485 A
	4	CAN H
	5	RS485 B
	6	CAN L
	7	+5 V DC
	8	GND

Phoenix Contact Connector 180° DFMC 0,5/4-ST-2,54 (Phoenix 1844594)

S1

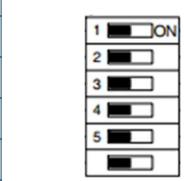
CAN Address	Switch	Signal Name
	1	Address 1
	2	Address 2
	3	Address 3
	4	Address 4
	5	CAN Termination (121 Ω)
	6	RS485 Termination (121 Ω)

### 3.2.8. DIO Connector (X50)

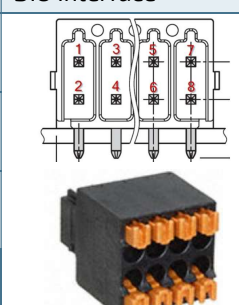
DIO Interface	Pin	Signal Name	Pin	Signal Name
	1	DOUT1 / DIN1 DOUT I <sub>max</sub> = 500 mA	2	GND
	3	DOUT2 / DIN2 DOUT I <sub>max</sub> = 500 mA	4	GND
	5	DOUT3 / DIN3 DOUT I <sub>max</sub> = 500 mA	6	GND
	7	DOUT4 / DIN4 DOUT I <sub>max</sub> = 500 mA	8	GND

### 3.2.9. USB Debug Connector (X70)

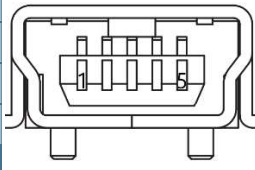
USB Mini-B Connector	Pin	Signal Name
	1	VCC
	2	RXD
	3	TXD
	4	N.C.
	5	GND

An additional adapter is needed to translate the UART signals provided on the Mini-B USB connector to USB. This adapter must be connected between an USB port on your computer and the debug interface on the AL Pi-Tron CM4 board using a standard USB cable.

Figure 9: UART-USB Adapter

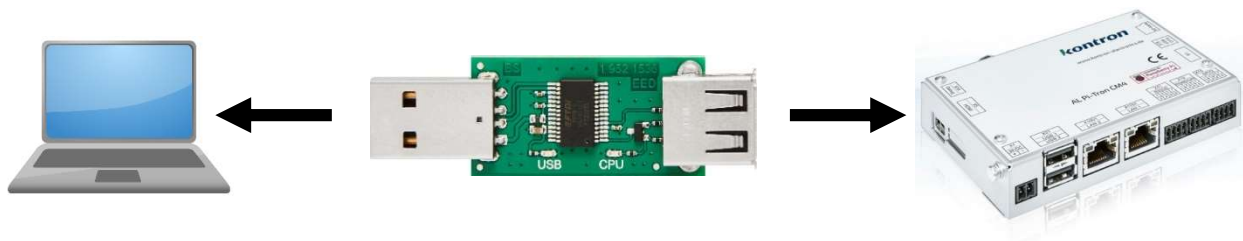

This adapter is only supplied as standard with our development kits but can also be ordered separately.

For more detailed information please have a look at the online documentation <https://docs.kontron-electronics.de>.

This documentation includes all information you need to put your device into operation including a quick start guide as well as further information on how to install an operating system.

### 3.2.10. USB OTG Connector (X60)

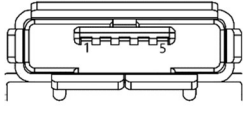
Micro-USB Connector	Pin	Signal Name
	1	+USB_VCC
	2	D-
	3	D+
	4	ID
	5	GND

### 3.2.11. MicroSD Card Slot (microSD)

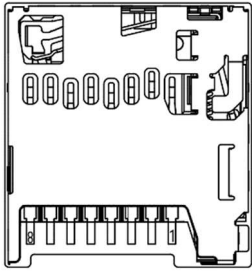
MicroSD Card	Pin	Signal Name
	1	DAT2
	2	CD/DAT3
	3	CMD
	4	VDD
	5	CLK
	6	VSS
	7	DAT0
	8	DAT1



Pay attention to the manufacturer's lifespan specification. Due to the limited lifespan of SD cards/SSD drives Kontron Electronics recommends checking the condition regularly.

## 4/ Accessing Components

This chapter contains important information that users must read before accessing components. Follow these procedures properly when accessing or installing component to extend the system.



The AL Pi-Tron CM4 is factory configured to meet customer requirements. Kontron Electronics does not recommend opening the system as this may cause damage to internal components. There is a protection label on the AL Pi-Tron CM4.

If the product is opened within the warranty period, the warranty is void.



The installation/removal of system components may only be performed by a qualified person. Observe the "General Safety Instructions for IT-Equipment" and the "installation instructions" contained within this user guide.



### ESD Sensitive

Follow the safety instructions for components that are sensitive to electrostatic discharge (ESD). Failure to observe this warning notice may result in damage to the product or/and internal components.



Because of the limited predetermined lifespan of expansion devices, Kontron Electronics recommends checking the condition of installed expansion devices regularly and to pay attention to the manufacturer specifications for lifespan.

### 4.1. Accessing External Components

#### 4.1.1. MicroSD Card Slot

The AL Pi-Tron CM4 supports a removable microSD card.

To remove/install a removable microSD card, perform the following steps:

1. Press the microSD card on the right-hand side of the AL Pi-Tron CM4 to remove a microSD card out of the slot.
2. The microSD card automatically slides out a bit for removal.
3. Slide in the microSD card, if needed. Take care of the correct position.

### 4.2. Accessing Internal Components

#### 4.2.1. Opening the Chassis



The AL Pi-Tron CM4 is factory configured to meet customer requirements. Kontron Electronics does not recommend opening the system as this may cause damage to internal components. There is a protection label on the AL Pi-Tron CM4.

If the product is opened within the warranty period, the warranty is void.

## 5/ Thermal Considerations

---

### Hot Surface - Housing

Danger of burns. Housing can get very hot. To avoid burns and personal injury:

**⚠ WARNING**

- Do not touch the housing when the product is in operation
  - Allow the product to cool before handling
  - Wear protective gloves
  - Always turn the product off when not in use
- 

The AL Pi-Tron CM4 is a fanless and passively cooled system. When mounting the AL Pi-Tron CM4 in a DIN rail enclosure or housing take care not to obstruct the airflow over the chassis, as this stops sufficient heat dispersing into the ambient environment and causes a build-up of heat.

## 6/ Installation Instructions

### 6.1. DIN Rail Mounting

The AL Pi-Tron CM4 is a rail mount PC box designed for use in a DIN rail enclosure or housing by attaching a DIN rail mounting clamp. The DIN rail mounting clamp can be attached on the rear side of the chassis.

To attach the DIN Rail mounting clamp, follow the steps below:

1. Make sure that the DIN Rail mounting clamp is in the upright position.
2. Clip the top of the DIN rail clamp into the DIN rail and push the bottom of the DIN rail firmly until it clamps on to the bottom of the DIN rail.

### 6.2. Power Connector

The AL Pi-Tron CM4 is connected by the input power connector on the front panel to a DC power source via a DC power supply wiring consisting of the power mating connector and the assembled wires. For information on how to wire the connector, see Chapter 6.2.1: Wiring the DC Mating Power Connector.

Figure 10: Phoenix Power Mating Connector

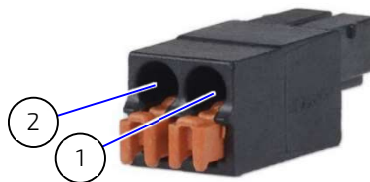

- 1 Location for inserting the 24 V wire
- 2 Location for inserting the 0 V / GND wire

#### 6.2.1. Wiring the DC Mating Power Connector

To wire the power mating connector, follow the steps below.

1. Cut two (0.5...1.5 mm<sup>2</sup>) AWG 20...16 isolated wires to the required length and strip each end 5...7 mm.
2. Twist the striped wire-ends and provide them with ferrules.
3. Press the contact levers of the power mating connector down - far enough so that you can insert the end of the prepared wires.
4. Insert the wires into the corresponding clamp of the Phoenix power mating connector. Make sure that you have the right polarity of the connection. For the pin assignment of the input power connector, refer to Chapter 3.2.1: Input Power Connector.



---

The wires used for power connections must be clearly marked (+/-) to ensure proper connection to the front panel input power connector and to the main power source. In addition, the cables must have some form of support to minimize the strain on the unit's connectors.

---



## 7/ Starting Up

Before using the system, become familiar with the system components and follow the startup instructions below.

### 7.1. Connecting to Power Supply

The AL Pi-Tron CM4 is connected to a DC main power supply via a Phoenix Contact input power connector on the front panel and corresponding power cable.



---

When starting the AL Pi-Tron CM4, the functional earth connection must always be made first and disconnected last. Kontron Electronics recommended that the last connections attached to the system should be the power cable. Following a proper cabling procedure will prevent a false power-on condition, which could result in an operational failure.

---

#### **CAUTION**

---

The AL Pi-Tron CM4 must be connected to a DC mains power supply complying with the SELV (Safety Extra Low Voltage) requirements of EN 60950-1 standard. It must be observed that wiring and short-circuit/overcurrent protection is performed according to the applicable standards, regulations and respect to the electrical specification of the AL Pi-Tron CM4. The disconnecting device (fuse/circuit breaker) rating must be in accordance with the AL Pi-Tron CM4's wire cross-section.

---

To start the AL Pi-Tron CM4, follow the steps below:

1. Ensure that the DC power source is switched off via a disconnecting device (circuit breaker), to ensure that no power is flowing from the external DC power source during the connection procedure.
2. Connect the power connector with wiring (refer to Chapter 6.2: Power Connector and Chapter 6.2.1: Wiring the DC Mating Power Connector) to the Input power connector located on the front panel, see Figure 8: Front Panel (pos. 1). Pay attention to the polarity of the connections. For more information on the input power connector's polarity, see Chapter 3.2.1: Input Power Connector.
3. Connect the DC power cable's other end to the DC main power supply.
4. Switch on the disconnecting device (circuit breaker) to apply voltage to the AL Pi-Tron CM4.

#### **NOTICE**

---

Do not disconnect the power from AL Pi-Tron CM4 while powered up!  
Performing a forced shutdown can lead to loss of data or other undesirable effects!

---

### 7.2. Operating System (OS) and Drivers

If ordered without pre-installed OS, before starting the AL Pi-Tron CM4, the operating system and the appropriate drivers need to be installed for the ordered system configuration.

The standard AL Pi-Tron CM4 is supplied without pre-installed OS and drivers. Drivers are available from Kontron Electronics GitLab Server <https://git.kontron-electronics.de>.

Further information about this topic is also available online at <https://docs.kontron-electronics.de>.

## 8/ Standards, Certifications and Directives

The AL Pi-Tron CM4 is currently in test and aims to comply with the requirements of the following standards.



If the user modifies the product, prerequisites for specific approvals such as CE conformity declaration (safety requirements) may no longer apply.

Table 10: Standards, Certifications and Directives Compliance

CE-Mark Compliant with EU Directives	Electromagnetic Compatibility	Directive 2014/30/EU
	Low Voltage	Directive 2014/35/EU
	RoHS II	Directive 2011/65/EU
EMC 2014/30/EU Immunity/ Emission	EN 61000-6-2:2019 EN 61000-6-4:2020	Electromagnetic compatibility (EMC), part 6-2: Generic standards- Immunity for industrial environment Electromagnetic compatibility (EMC), part 6-4: Generic standards- Emission for industrial environment
Low Voltage 2014/35/EU	EN 62368-1:2021	Audio/Video, information and communication technology equipment Part 1: Safety requirements
WEEE 2002/96/ EC	Waste Electrical and Electronic Equipment Directive (WEEE Directive)	Compliant with the Waste Electrical and Electronic Equipment (WEEE) directive to reduce waste of electrical and electronic equipment, encourage recycling and environmental disposal and increase the environmental awareness of producers.

## 9/ Shipment and Unpacking

### 9.1. Packaging

All parts are delivered together in a product specific cardboard package designed to provide adequate protection and absorb shock. Kontron Electronics recommends keeping the packaging to store or transport the product.

### 9.2. Unpacking

Proceed as follows to unpack the unit:

1. Remove packaging.
2. Do not discard the original packaging. Keep packaging for future relocation or storage.
3. Check the delivery for completeness by comparing it with the original order.
4. Keep the associated paperwork. It contains important information for handling the unit.
5. Check the contents for visible shipping damage.
6. If you notice any shipping damage or inconsistencies between the contents and the original order, contact Kontron Electronics for help and information.

### 9.3. Type Label and Product Identification

The type label contains the following information:

Figure 11: AL Pi-Tron CM4 Type Label (Example)

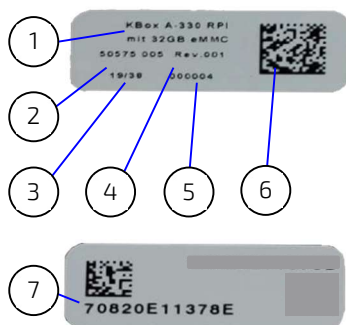

1. Product name (AL Pi-Tron CM4)
2. Article number
3. Production date
4. Revision number
5. Serial number
6. Barcode with article-, rev., date and serial number
7. MAC address (LAN1)

## 10/Technical Support

### 10.1. First Steps – Startup-Information Baseboard

For the first startup of your board, you will find more information about the software / BSP (demo) and additional hardware information at the online documentation.

Please follow the link: <https://docs.kontron-electronics.de/sw/ked/raspberry-pi/pi-tron/cm4-docs/quickstart/>

The online documentation is primarily intended for our Eval-Kit / Evalboard but will help you also to put your AL Pi-Tron CM4 into operation.

### 10.2. Extended Support

For detailed technical support please contact:

- ▶ E-Mail: [support@kontron-electronics.de](mailto:support@kontron-electronics.de)

Make sure you have the following product identification information in your e-mail:

- ▶ Product name
- ▶ Product model number
- ▶ Serial number (SN) of the unit

Please explain the nature of your problem in your e-mail.



---

The serial number can be found on the type label on the system.

---

### 10.3. Disclaimer & License Information

The demo software contained in the device (BSP) contains parts which were licensed as free respectively open-source software under the GNU General Public License, version 2 and/or 3, respectively the GNU Lesser General Public License, versions 2.1 and/or 3.0.

Kontron Electronics GmbH  
Max-Planck-Str. 6  
72636 Frickenhausen  
Germany  
Web: <http://www.kontron-electronics.com/>  
E-Mail: [support@kontron-electronics.de](mailto:support@kontron-electronics.de)

## 11/Storage, Transportation and Maintenance

### 11.1. Storage

If the product is not in use for an extended period time, disconnect the power plug from the AC outlet. If it is necessary to store the product then re-pack the product as originally delivered to avoid damage. The storage facility must meet the products environmental requirements as stated within this user guide. Kontron Electronics recommends keeping the original packaging material for future storage or warranty shipments.

### 11.2. Transportation

To ship the product, use the original packaging, designed to withstand impact and adequately protect the product. When packing or unpacking products always take shock and ESD protection into consideration and use an EOS/ESD safe working area.

### 11.3. Maintenance

Maintenance or repair on the open product may only be carried out by qualified personnel authorized by Kontron Electronics.

#### Cleaning

- ▶ For light soiling, clean the product with a dry cloth.
- ▶ Carefully remove dust from the surface of the chassis and cooling fins using a clean, soft brush.
- ▶ Stubborn dirt should be removed using a mild detergent and a soft cloth.

#### **NOTICE**

Do not use steel wool, metallic threads or solvents like abrasives, alcohol, acetone or benzene for cleaning the AL Pi-Tron CM4.

#### 11.3.1. Replacing the Lithium Battery

The lithium battery must only be replaced with the same type of battery or with a type of battery recommended by Kontron Electronics. If the on-board Lithium battery needs to be replaced, follow the steps below:

1. Remove the lithium battery by gently pulling the battery cable upwards.
2. Connect the new lithium battery to the board, observe the plug's keying.
3. Pay attention to the polarity of the battery.

#### **CAUTION**

Danger of explosion when replacing with wrong type of battery. Replace only with the same or equivalent type recommended by the manufacturer. The lithium battery type must be UL recognized.



Do not dispose of lithium batteries in general trash collection. Dispose of the battery according to the local regulations dealing with the disposal of these special materials, (e.g. to the collecting points for dispose of batteries).

## 12/Warranty

Kontron Electronics defines product warranty in accordance with regional warranty definitions. Claims are at Kontron Electronics discretion and limited to the defect being of a material nature. To find out more about the warranty conditions and the defined warranty period for your region, following the steps below:

1. Visit Kontron Electronics Term and Conditions webpage

<http://www.kontron-electronics.de/downloads>

2. Click on the relevant document



---

**The AL Pi-Tron CM4 is factory configured to meet customer requirements. Kontron Electronics does not recommend opening the system as this may cause damage to internal components.**

---

### 12.1. Limitation/Exemption from Warranty Obligation

In general, Kontron Electronics shall not be required to honor the warranty, even during the warranty period, and shall be exempted from the statutory accident liability obligations in the event of damage caused to the product due to failure to observe the following:

- ▶ General safety instructions for IT equipment within this user guide.
- ▶ Warning labels on the product and warning symbols within this user guide.
- ▶ Information and hints within this user guide.

Additionally, alterations or modifications to the product that are not explicitly approved by Kontron Electronics, described in this user guide, or received from Kontron Electronics Support as a special handling instruction will void your warranty.

Within the warranty period, the product should only be opened by Kontron Electronics. Removing the protection label and opening the product within the warranty period exempts the product from the statutory warranty obligation.

Due to their limited service life, parts which by their nature are subject to a particularly high degree of wear (wearing parts) are excluded from the warranty beyond that provided by law.

## 13/Disposal

Final disposal of this product after the product's service life must be accomplished in accordance with the applicable country, state, or local laws or regulations.



---

**Kontron Electronics manufactures products to satisfy environmental protection requirements where possible. Many of the components used are capable of being recycled.**

---

Kontron Electronics follows the Waste Electrical and Electronic Equipment (WEEE) Directive that aims to reduce waste arising from Electrical and Electronic waste and encourages customers to return Kontron Electronics products for proper disposal. For more information regarding WEEE compliance, see the Disposal and Recycling section at the start of this user guide.

# Appendix

## List of Acronyms

Table 11: List of Acronyms

AC	Alternating Current
AIN	Analog Input
AL	Automation Line (Board with housing)
BL	Board Line (Board without housing)
BSP	Board Support Package (Software)
CAN	Controller Area Network (BUS)
CPI	Advanced Configuration Control Interface
CPU	Central Processing Unit
CSI	Camera Serial Interface
DC	Direct Current
DIN	Deutsches Institut für Normung, German Institute for Standardization (Standards)
DIO	Digital Input/Output
DK	Development Kit
DL	Display Line (Board with Display)
DOUT	Digital Output
DP	Display Port
DSI	Display Serial Interface
ECC	Error Checking and Correction
EEE	Electrical and Electronic Equipment
EHCI	Enhanced Host Controller Interface
EMC	Electromagnetic Compatibility
eMMC	Embedded MultiMediaCard
EN	European Norm (Standards)
ESD	Electrostatic Discharge
ETH	Ethernet (LAN)
GbE	Gigabit Ethernet
GPIO	General-Purpose Input/Output
GPU	Graphics Processing Unit
HD/HDD	Hard Disk /Drive
HDMI	High-Definition Multimedia Interface
HPM	PICMG Hardware Platform Management specification family
H/W	Hardware
IEC	International Electrotechnical Commission (Standards)
IOL	IPMI-Over-LAN
IOT	Internet of Things
KVM	Keyboard Video Mouse

LAN	Local Area Network
LED	Light Emitting Device / Diode
LPDDR	Low-Power Double Data Rate (RAM)
LVD	Low Voltage Device
M.2	Next smaller generation of mSATA
MEI	Management Engine Interface
mPCIe	Mini PCI-Express
mSATA	Mini SATA
OS	Operating System
PCIe	PCI-Express
RAM	Read Access Memory
REV	Revision
RoHS	Restriction of the use of certain hazardous substances
ROM	Read-only memory
RPI	Raspberry Pi
RTC	Real Time Clock
SATA	Serial-ATA
SEL	System Event Log
SELV	Safety Extra Low Voltage
SIO	Super Input/output
SMBus	System Management Bus
SMWI	System Monitor Web Interface
SN	Serial Number
SOL	Serial Over LAN
SSD	Solid State Drive
TPM	Trusted Platform Module
UEFI	Unified Extensible Firmware Interface
uHDMI	Micro-HDMI
UL	Underwriters Laboratories (Standards)
USB	Universal Serial Bus
USB OTG	USB On-The-Go (Host)
uSD	microSD (Memory Card)
VGA	Video Graphics Array
VLP	Very Low Profile
WEEE	Waste Electrical and Electronic Equipment
WLAN	Wireless LAN
XHCI	eXtensible Host Controller Interface





## About Kontron Electronics

Kontron Electronics is your complete supplier of electronics and automation solutions. We offer

- ▶ own control products for the automation of machines and devices,
- ▶ development and production for individual, complex electronic modules
- ▶ production services for your existing electronic assemblies
- ▶ assembly services for complete systems

With our existing control, visualisation and automation systems, we can put together turnkey complete solutions for your machines and equipment in the shortest possible time. For your individual requirements we have a large group of engineers and technicians available, who develop your tailor-made solution with a lot of experience and imagination. Kontron Electronics is a full-service provider for the development and production of complex electronic modules, components and systems for industrial and medical applications.



## Kontron Electronics GmbH

Max-Planck-Str. 6  
72636 Frickenhausen  
Germany  
Tel.: + 49 7022 4057-0  
Fax: + 49 7022 4057-22  
info@kontron-electronics.de